

optimize!
softing

WireXpert 4500

ENGLISH



Copper USER MANUAL

IT Networks



itnetworks.softing.com

WireXpert

Disclaimer of liability

The information contained in these instructions corresponds to the technical status at the time of printing of it and is passed on with the best of our knowledge. The information in these instructions is in no event a basis for warranty claims or contractual agreements concerning the described products, and may especially not be deemed as warranty concerning the quality and durability. We reserve the right to make any alterations or improvements to these instructions without prior notice. The actual design of products may deviate from the information contained in the instructions if technical alterations and product improvements so require.

It may not, in part or in its entirety, be reproduced, copied, or transferred into electronic media.

Softing Singapore Pte Ltd

73 Science Park Drive
#02-12/13 Cintech I
Singapore Science Park 1
Singapore 118254
<http://itnetworks.softing.com>



+ 65 6569 6019



+ 65 6899 1016



asia-support.itnetworks@softing.com

The latest version of this manual is available in the Softing download area at: <http://itnetworks.softing.com>.

Table of Contents

Table of Contents	3
1 Introduction	6
1.1 About product	6
1.2 Safety precautions	6
1.3 Intended use	7
1.4 About this document	7
1.5 Before you start	8
1.6 Scope of delivery	8
1.7 System requirements	9
2 WireXpert PC Software and Firmware	11
2.1 Install software.....	11
2.2 Upgrade firmware	11
3 Understanding WireXpert	13
3.1 WireXpert Overview.....	13
3.2 Dual Control System (DCS)	14
3.3 WireXpert Adapters	14
3.4 Cabling Certification and Testing.....	15
3.5 Memory	17
3.6 Battery Information	18
3.7 Power Supply	19
3.8 Dimension	19
3.9 Environmental Conditions.....	19
4 WireXpert User Interface	20
4.1 Touch Screen Layout	20
4.2 The One Touch Access Button.....	21
5 Setting Reference	42
6 Configuring an AUTOTEST	43
6.1 Setting up WireXpert.....	43
6.2 Testing Guide for Permanent Link Testing	44
6.3 Testing Guide for Channel Testing	45
7 Performing an AUTOTEST	46
7.1 Understanding AUTOTEST	46
7.2 NEXT and RL Fault Locating	48
7.3 Managing test result(s)	49
7.4 Exporting test results into eXport PC Software	51
8 Declarations	54
9 Appendix	57
10 Glossary	59

11	Related documents.....	62
12	Technical Support.....	63

This page is left intentionally blank

1 Introduction

1.1 About product

Softing's WireXpert, with its unparalleled 2,500 MHz measurement range, is the first cable certifier with capability to certify the highest performance cabling systems in enterprise networks and data centers. Cable installers make significant gain in productivity with WireXpert's industry leading test speed and ease of use. With certification testing up to Class FA and CAT8 copper cabling, as well as MPO, SM, MM and MMEF fiber optic cabling, WireXpert is ready for 40G and beyond.

Starting from v7.4, WireXpert is available in four variants- WireXpert 500 copper (up to 500MHz) only, WireXpert 500 fiber only, WireXpert 500-plus; copper + fiber and WireXpert 4500- to provide more flexibility to suit your certification requirements. The WireXpert 500 series provides an affordable solution that can grow with your cable certification needs. Upgrade the copper only or fiber only variants to the combined WireXpert 500-plus or WireXpert 4500 for the full 2,500MHz capability.

With v8.0, cloud-based data management features have been integrated into WireXpert and eXport PC Software. Users will be able to connect unlimited numbers of WireXpert and transfer test data to and from their private network using Wi-Fi or mobile hotspot. The cloud feature is available in all variants of WireXpert.

1.2 Safety precautions



Read this manual before starting

For damages due to improper connection, implementation or operation Softing refuses any liability according to our existing warranty obligations.



Note

This symbol is used to call attention to notable information that should be followed during installation, use, or servicing of this device.



Hint

This symbol is used when providing you with helpful user hints.



CAUTION

Selection of option may cause all or partial of saved data and/or settings in the device to be erased or restored to non-reversible original factory state. Backing up of saved result(s) is recommended before executing option.



CAUTION

CAUTION indicates a potentially hazardous situation which, if not avoided, may result in minor or moderate injury.



WARNING

WARNING indicates a potentially hazardous situation which, if not avoided, could result in death or serious injury



DANGER

DANGER indicates an imminently hazardous situation which, if not avoided, will result in death or serious injury. This signal word is to be limited to the most extreme situations.

1.3 Intended use

WireXpert series has been designed for use in factory, process and building control. The unit must not be used in explosion hazard areas. The permissible ambient conditions given in the Technical Data must be complied with.

The faultless and safe operation of the product requires proper transport, proper storage and installation, and expert operation and maintenance in accordance with the manual.

1.4 About this document



Read this manual before starting

For damages due to improper connection, implementation or operation Softing refuses any liability according to our existing warranty obligations.

1.4.1 Document history

Document version	Modifications compared to previous version
201702	Firmware update to v7.3
201811	Firmware update to v8.0
201908	Firmware update to v8.1

1.4.2 Conventions used

The following conventions are used throughout Softing customer documentation:

Fehler! Verwenden Sie die Registerkarte 'Start', um Heading 1 dem Text zuzuweisen, der hier angezeigt werden soll.

Keys, buttons, menu items, commands and other elements involving user interaction are set in bold font and menu sequences are separated by an arrow	Open Start → Control Panel → Programs
Buttons from the user interface are enclosed in brackets and set to bold typeface	Press [Start] to start the application
Coding samples, file extracts and screen output are set in Courier font type	MaxDlsapAddressSupported=23
Filenames and directories are written in italic	Device description files are located in <i>C:\<product name>\delivery\software\Device Description files</i>

1.5 Before you start

Check that the latest eXport PC software and firmware is installed in the workstation and WireXpert respectively to ensure the latest features are available.

Key differences between WX4500 and WX500 series

Features	WX4500-FA	WX500-PLUS	WX500-CU	WX500-FIBER
Frequency of measurement	2500 MHz	500 MHz	500 MHz	N/A
Accuracy Specification	TIA Level 2G ISO/IEC Level VI	TIA Level IIIe ISO/IEV Level IIIe	TIA Level IIIe ISO/IEC Level IIIe	N/A
Fiber Testing option	Yes	Yes	No	Yes
Class FA/CAT 8 options	Yes	No	No	No
Patch Cord Test adapters	Yes	Yes	Yes	No

Softing recommends WireXpert to be calibrated annually. Starting from v7.4, WireXpert will remind the user to calibrate the units if the last calibration was more than one year ago. This notification can be closed by clicking the **[OK]** button, but will be displayed on every boot up until the units are calibrated.

Calibration can only be done by the service center. Please contact your local vendor for more information.

1.6 Scope of delivery

WireXpert WX-4500-FA or WX-500-CU comprises the following parts:



Soft or Hard carrier case
(WX_AC_SOFTCASE) or
(WX_AC_HARDCASE)



WireXpert WX4500 or
WireXpert WX500
(LOCAL and REMOTE)

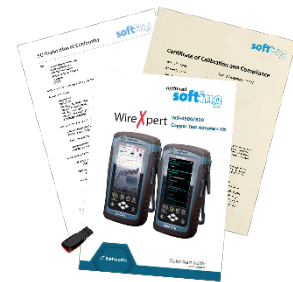

Calibration Certificate
& USB Flash Drive



Power Adapters -
Input: 100-240VAC/1.2A
Output: 12VDC/3.0A
(WX_AC_PWRAD)



Talk-set headphones
(WX_AC_TALKSET1)



LCD Protective Cover
(WX_LCD_COVER)



CAT 6A Channel
adapters
(WX_AD_6ACH2)



Permanent Link
adapters & cords
(WX_AD_6ALKIT2)

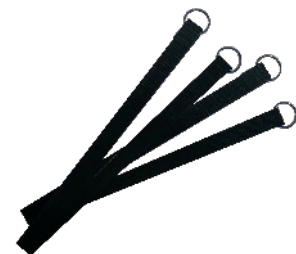

Straps

1.7 System requirements

Hardware

- PC

Operating system

- Windows 7, 8.x or 10 (32 bit or 64 bit)
- Intel Core 2 Duo, 2GHz
- 1 GB of RAM

Fehler! Verwenden Sie die Registerkarte 'Start', um Heading 1 dem Text zuzuweisen, der hier angezeigt werden soll.

- 200 MB of free space of installation
- Microsoft .NET framework

2 WireXpert PC Software and Firmware

2.1 Install software

- 1 Download the latest eXport PC software from <https://itnetworks.softing.com/>
- 2 Run eXport setup v8.x.x64.exe
- 3 Follow through the instructions on the screen and click [Next] to proceed.
- 4 Click **[Install]** to begin installation.
- 5 Click **[Finish]** to complete installation.
- 6 If this is an upgrade from an earlier version from 6.x and above, click **[Yes]** to proceed.

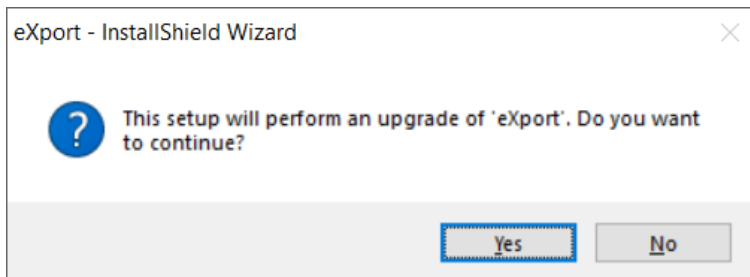

- 7 Follow the instructions to complete installation.



User Manuals

For more information on installation and using eXport PC software, please refer to “Installation Guide for eXport PC software” and “User Manual for eXport PC software”.



Note

Softing IT Networks has ceased support for ReportXpert v5.x and earlier. Please contact asia-support.itnetworks@softing.com for more information.

2.2 Upgrade firmware

- 1 Download and install the latest eXport PC software.
- 2 Connect an USB flash drive to the workstation.
- 3 Run eXport PC software.
- 4 Go to **Tools** → **Update Device Firmware**
- 5 Click **[OK]** and select USB drive from “Export to USB” window.
- 6 Click **[Export]** and **[OK]** to proceed.
- 7 Please wait while exporting takes place. This process may take a while.
- 8 Remove USB flash drive from workstation and connect to WireXpert.
- 9 Select **[Upgrade Firmware]** from prompt and click **[OK]** button to continue.
Note: Both LOCAL and REMOTE units must be upgraded.

Fehler! Verwenden Sie die Registerkarte 'Start', um Heading 1 dem Text zuzuweisen, der hier angezeigt werden soll.

- 10 If prompt did not appear, check that  USB icon is present on the status bar, and press the **[SETUP]** button → **System Settings** → **Settings 2** → **Storage** → **USB**.
- 11 Please wait while upgrading takes place. This process may take a while.
- 12 Upgrade process is complete.



CAUTION

Saved test results and settings may be erased during upgrading. You are recommended to save all test results before upgrading the firmware.

3 Understanding WireXpert

3.1 WireXpert Overview

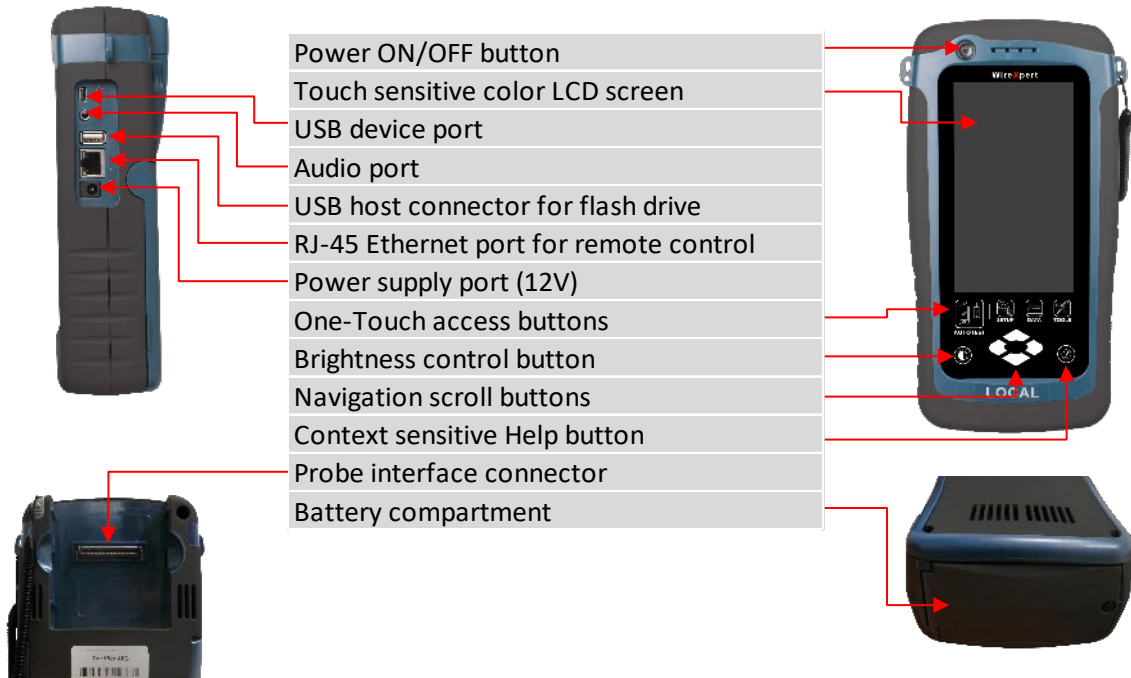

Part	Functionality
Power ON/OFF Button	To turn on the device, press the power button for 5 seconds. To turn off the device, press the power button, and select OK on the power off dialog box. Alternately, press and hold the power button for 10 seconds (not recommended). The LED in the power button turns green if the unit is turned on. The LED on the power button turns red when the device is charging in stand-by mode, orange if it's turned on.
Touch Sensitive LCD screen	Performs test executions and viewing of results.
USB device port	Enables remote connection to the PC for remote control update and exporting saved results.
Audio port	Enables vocal communication between LOCAL and REMOTE units when connected to talk set headphones (WX_AC_TALKSET).
USB Host port	Enables results to be exported and firmware upgrade via USB flash drive. Enables loading of custom limits and labels for list-based testing.
RJ-45 Ethernet port	Enables communication between two sets of WireXpert for Alien Crosstalk testing. Currently not available.
Power Supply port	Performs charging of device when connected to power adapter shipped with WireXpert. (WX_AC_PWRAD)
One-touch access buttons	Main functional buttons AUTOTEST, SETUP, DATA and TOOLS for WireXpert. Enables quick AUTOTEST and results viewing in a single click.
Brightness Control	Adjusts the brightness level of the LCD display.
Navigation scroll buttons	Performs navigation in long lists.
Context sensitive help	Provides simple explanation relevant to the functionality on the current screen (available in future version).

Fehler! Verwenden Sie die Registerkarte 'Start', um Heading 1 dem Text zuzuweisen, der hier angezeigt werden soll.

Part	Functionality
Probe interface connector	When connected with different probe adapters (e.g. CAT6A channel or Permanent Link), WireXpert will enable specified certification test to be conducted.
Battery compartment	Battery storage compartment. Unscrew to replace battery (WX_AC_BAT1).

3.2 Dual Control System (DCS)

WireXpert consists of two identical devices, LOCAL and REMOTE, for dual-end testing and certification. Both devices utilize easy to use LCD touch-screen technology and graphical user interface. The DCS ensures the same graphical data on the LOCAL units are received on the REMOTE unit real-time, improving efficiency and productivity significantly as test data and settings can be viewed from REMOTE and LOCAL side.

In the event of a wire map failure, the DCS will enable the operator on the far-end to visually identify which pair of wires is causing the error, instead of just a LED indication on traditional testers.

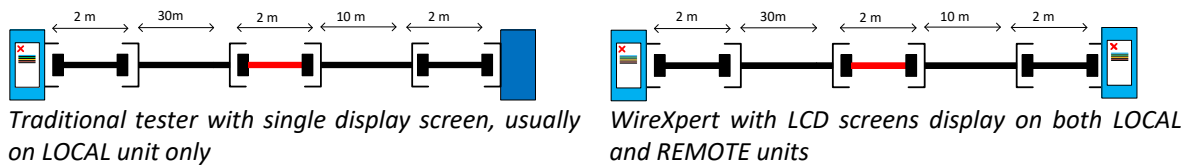

3.3 WireXpert Adapters

All test adapters are designed to fit onto every WireXpert units. The device automatically detects adapters when connected and prompts to change in the matching interface depending on the type of adapter. Press the **[SETUP]** button → **Quick Setup** to change the test limit using generic configurations.

3.3.1 Permanent Link (PL) and Channel (Ch) Adapters

Every standard WireXpert kit includes adapters for testing copper cablings in Permanent Link and Channel configurations.

Channel adapters connect to the patch cords at the wall plates and telecommunication panels. WireXpert software compensates for the adapter’s transmission characteristics to ensure test results’ accuracy.

Permanent Link adapters connect to the wall plates and telecommunication panel jacks. WireXpert software compensates for the adapter’s transmission characteristics to ensure test results will not be affected.

WireXpert’s Permanent Link adapters’ high precision interface reduces the degrading issue between the RJ-45 jack and link cord, providing highly accurate and repeatable measurements, and cost-efficient method of replacing the link cords instead of the expensive link adapters.

3.3.2 Adapter Configuration Warnings

WireXpert will display a warning a potential conflict is detected between the adapter and the test settings. It is important to use the appropriate adapters as accuracy of measurements will be affected.

3.3.3 Adapter Insertion Counts

Every WireXpert adapter can keep track of the number of tests performed. This data ensures up to date information on the adapter's lifespan. WireXpert will indicate a warning when the adapter insertion counts have expired the specified insertion counts lifespan. This can be checked by pressing the **[SETUP]** button → **System Settings** → **System Settings 2** → **Device Info** → **Probe Test Count**

3.4 Cabling Certification and Testing

Certification testing with WireXpert is highly intuitive and simple. The AUTOTEST function performs a series of measurements between the LOCAL and REMOTE devices and analyses the results to determine if the cabling run passes or fails the selected standards.

3.4.1 Copper Cable Certification Testing

Test at both ends of structured twisted pair cables for the worst-case performance is required in accordance to the ISO/TIA standards. All certification testing requires a two-part test consisting of a main and remote unit, both bearing similar test capabilities. The test would be conducted with one end from the telecommunication closet, and the other at the outlet.

There are two primary considerations regarding the test method:

- Whether the user patch cords are included in the cabling run during the test.
 - If so, channel test configuration is required.
 - If not, link test configuration is required.
- Which standard – TIA or ISO should be used (Category or Class)

3.4.2 Permanent Link Configuration Tests

The Permanent Link configuration is generally used in facilities still under construction and does not include user patch cords. As the link configuration does not include the two additional connections of the patch cords, performance standards are more stringent. Special link adapters are used on both LOCAL and REMOTE units for links that are under test.

3.4.3 Channel Configuration Tests

User patch cords are included for the Channel configuration. The pass/fail limits for this configuration allows performance degradation inherent in the two additional patch cords included in the measurements, thus are less stringent. Special channel adapters are used on both LOCAL and REMOTE units for channels that are under test.

Fehler! Verwenden Sie die Registerkarte 'Start', um Heading 1 dem Text zuzuweisen, der hier angezeigt werden soll.

3.4.4 End-to-End (E2E) Link Configuration Tests

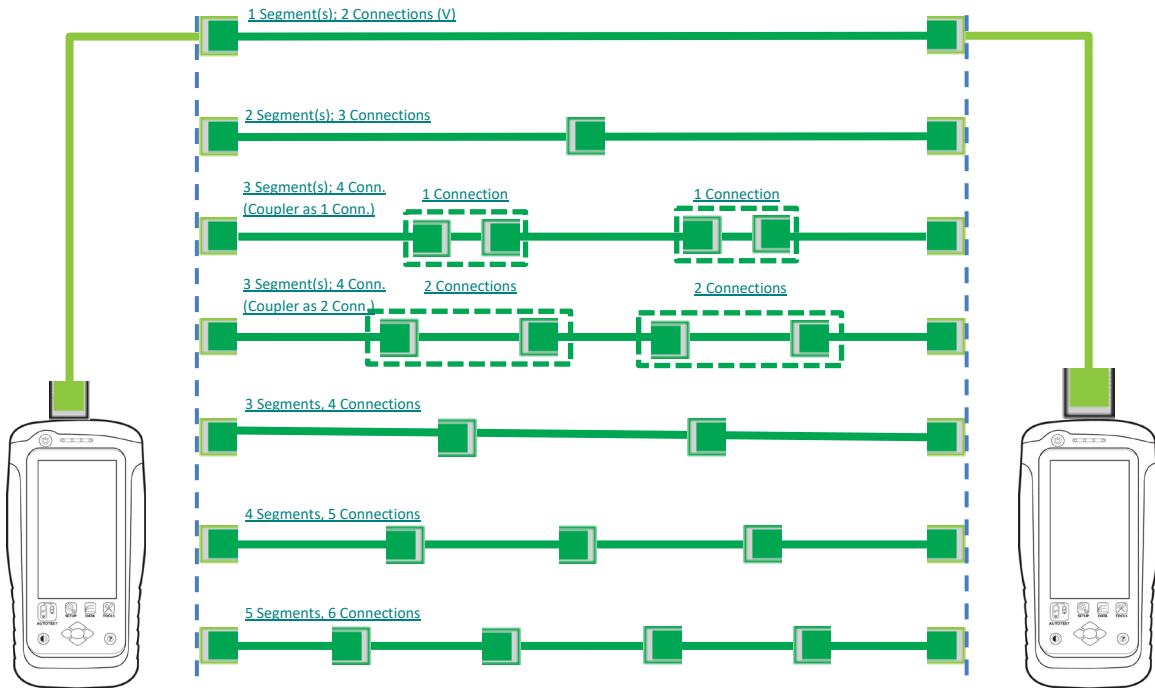

Starting from v7.3, WireXpert has included the E2E test limits to certify links that are more suitable for the industrial environment. E2E links are applicable when application is required to connect directly to machines or machines to network devices. The Industrial Ethernet test kit is required to perform a E2E link test. The Industrial Ethernet test kit consist of a pair of End-to-End test adaptors and test cords of TERA-TERA, TERA-RJ45, TERA-M12 D-coded or TERA-M12 X-coded variation depending on the application requirement. Press the **[SETUP]** button → **Test Settings** → **Test Limit** → **End to End** to select the required E2E test limit.

The Industrial Ethernet E2E test kit is not part of the standard WireXpert kit. Please contact your local vendor for more information.



User Guide

Refer “Application Notes - E2E Link Test” for more information.

3.4.5 Modular Plug Terminated Link (MPTL)

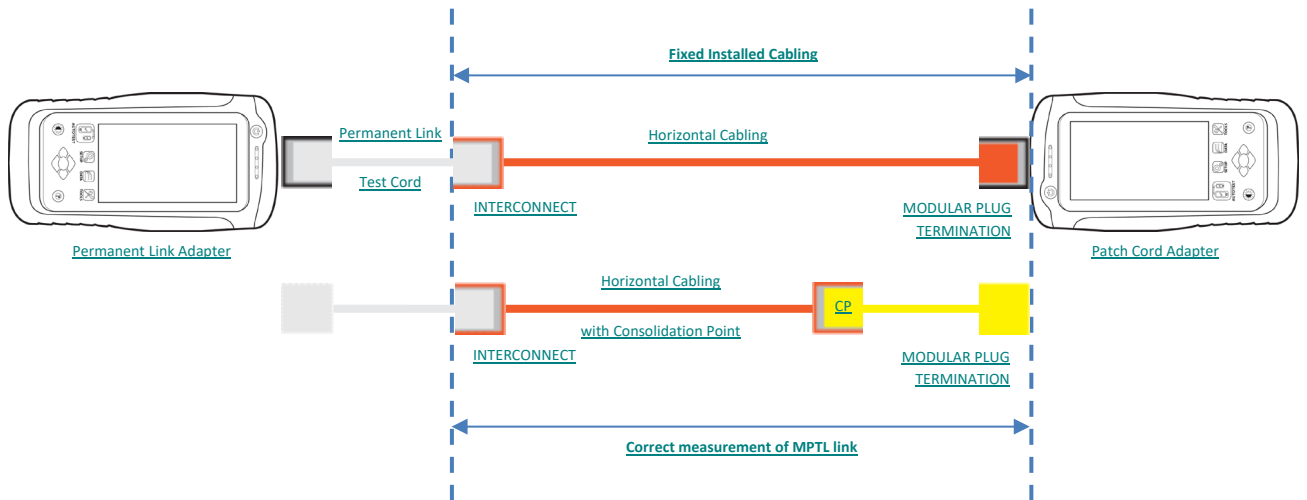

Starting from v7.4, WireXpert has included the MPTL test limits to certify links that features a socket on the patch panel, and a plug on the opposite side of the link. This is similar to the E2E link, however, is used when IP-capable devices are permanently installed, e.g, LED lights, building automation elements or surveillance cameras. The installation cable is plugged directly into the termination device without the addition of a socket plus patch cable. A Permanent Link and a Patch Cord test adapter is required to perform the MPTL test. Press the **[SETUP]** button → **Test Settings** → **Test Limit** → **TIA** to select the required MPTL test limit.

The Patch Cord adapter is not part of the standard WireXpert kit. Please contact your local vendor for more information.



User Guide

Refer "Application Notes - MPTL" for more information.

3.5 Memory

1 Gigabyte internal flash memory.

External USB Flash Drive included allows for flexible data management and storage.

WireXpert only supports FAT/FAT32/exFAT file system.

3.5.1 Memory Requirements

The amount of memory that each test result takes up depends on the options that is configured before starting the test. If plots are saved with each test, file size of test results will be generally larger than one that has plots option omitted.

WireXpert allocates approximately 1 GB of internal flash memory for test result storage.

3.6 Battery Information

WireXpert units are powered by Lithium Ion rechargeable batteries. These batteries contain circuitry that reports their state of charge to WireXpert. The units can be powered by external AC/DC power adapters.

A fully charged battery can operate WireXpert for five to eight hours before requiring recharging. Reducing the screen brightness and enabling the sleep function allows WireXpert to run longer on a charge.



Do not set reference or operate WireXpert while the battery is hot immediately after charging.

Make sure that the WireXpert is always operated within the allowed temperature range from 0-40°C. If a significant increase or decrease of the temperature is discovered, repeat the set reference procedure to remain the instrument's accuracy.



CAUTION

Use only the supplied power supplies with the WireXpert kit. Using other powers may damage the tester and void its warranty.

3.6.1 Battery Safety

- To avoid the risk of fire, burns or damage to your battery pack, do not allow metal objects to touch the battery contacts.
- The battery pack is suitable for use only with compatible WireXpert devices.
- Do not disassemble the battery pack. There are no user serviceable parts inside. Do not dispose the battery pack in fire or water.
- Handle a damaged or leaking battery with extreme care. If you come into contact with the electrolyte, wash the exposed area with soap and water. If the electrolyte contacts the eye, flush the eye with water for 15 minutes and seek medical attention.
- Do not expose the battery pack to high storage temperatures (above 55°C).
- When discarding a battery pack, contact your local waste disposal provider regarding local restrictions on the disposal or recycling of Lithium Ion batteries.
- To obtain a replacement battery (part number WX_AC_BAT1), contact your local dealer.
- Do not charge the batteries pack if the ambient temperature is above 40°C.

3.6.2 Replacing Battery

The batteries are located and secured at the bottom of the WireXpert units for safety reasons. To replace the batteries;

1. Switch off WireXpert and disconnect external power supplies.
2. Unscrew the battery compartment and remove the cover.

3. Remove and replace a new battery into the compartment.
4. Close, fasten and secure the screw onto the compartment cover.



3.7 Power Supply

- Removable/rechargeable Li-Ion batteries provide more than 8 hours of continuous operation.
- AC power: 100~240V AC plugs directly into the battery. Alternatively, the batteries can be recharged using an external charging kit that can be ordered separately (WX_AC_CHARGER).

3.8 Dimension

- Size: 223mmH x 124mmW x 74mmD
- Weight: approx. 1.0 kg (approx. 2.2 lbs.)

3.9 Environmental Conditions

- Operating temperature: 0°C to 40°C
- Storage Temperature: 20°C to 60°C
- Relative humidity: 10% to 80%

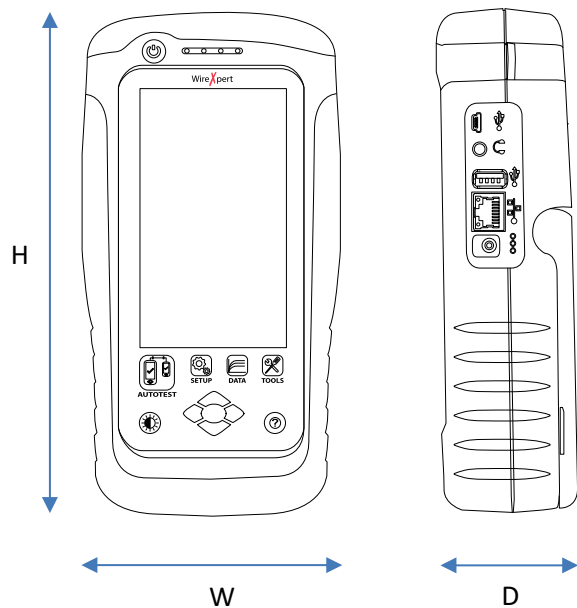

4 WireXpert User Interface

Starting from v7.3, users are required to read and agree to the “End User License Agreement (EULA)” on the first launch or after a firmware upgrade to use WireXpert. The EULA can be found in **[TOOLS] → About Us → Info** after agreeing the first time.

4.1 Touch Screen Layout

The Graphical User Interface (GUI) in version 7.0’s firmware has been updated with a more responsive system and quick-access menus.

WireXpert boots up to the SETUP screen. It is categorized into 5 groups:



1. Status bar
2. Quick Setup group
3. Test Settings group
4. Project Settings group
5. System Settings group

1. The **Status bar** displays the current date, Wi-Fi connectivity status, USB connectivity status, talk set connectivity status and battery level. Tap icons to change or view setting.
2. The **Quick Setup** group provides quick selection with predefined configurations.
3. The **Test Settings** group provides results-oriented configurations necessary to perform an AUTOTEST.
4. The **Project Settings** group provides non-results-oriented configurations before performing an AUTOTEST.
5. The **System Settings** group settings provides device, time, localization and device related configurations.

4.2 The One Touch Access Button

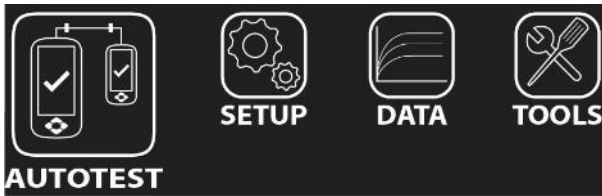

The fundamental philosophy behind the WireXpert User Interface is simplicity in its ease of use. The main functions of the One-Touch access buttons as follows:

4.2.1 The [AUTOTEST] button



The **[AUTOTEST]** button will perform an immediate certification test on the last configured settings. If no settings were configured, default settings will be used.

Test results will be generated automatically after the test is completed.

You will receive any of the following 4 results after performing AUTOTEST:



Green "PASS" – Good test result in accordance to pre-defined settings.



Green "PASS*" – "PASS" result with one or more test parameters that have margin in the range of uncertainty of the tester.



Red "FAIL" – Unacceptable results with severe disturbance on one or more test parameters.



Red "FAIL*" – "FAIL" result with one or more test parameters that have negative margin in the range of uncertainty of the tester.



Note

Marginal Pass/Fail is enabled by default. Press the **[SETUP]** button → **Test Settings** → **Test Options** → **Lab** → **Marginal Pass/Fail** to change the presentation of the test result to clear "PASS" or "FAIL" results. Uncertainty of the tester is then not taken into consideration. Contact Softing for more information.

You will be given the following option after performing an AUTOTEST:

- **[Retest]** can be conducted on a PASS or FAIL result (if list-based testing labelling scheme is selected).
- **[View]** details will display additional test parameters and plots.
- **[Save]** test results to device

An AUTOTEST will fail in the event of missing connection between the LOCAL and REMOTE units, wrong settings configured or if setting reference are required. WireXpert will perform an initial wire map test before testing other parameters. Disable wire map test at **Test Settings** → **Test Options** → **Lab** → **Wire map** to bypass this test.

Fehler! Verwenden Sie die Registerkarte 'Start', um Heading 1 dem Text zuzuweisen, der hier angezeigt werden soll.

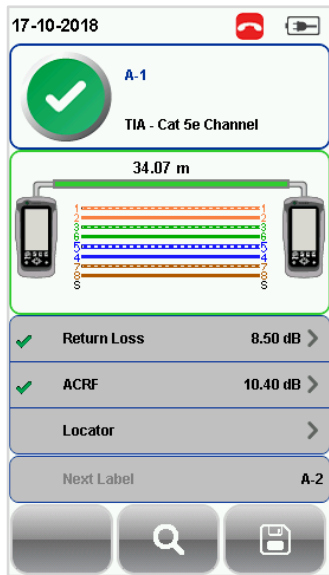

AUTOTEST results

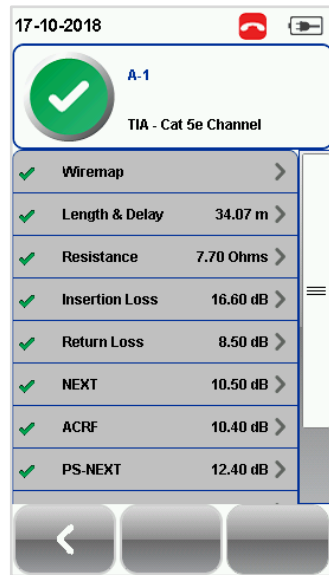

[View] detail results

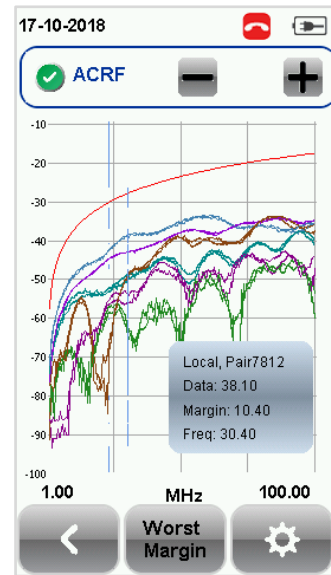

Plots

Two worst tested parameters will be displayed on the result summary screen. Press the **[View]** button to view detailed results.

The type of results will differ depending on the Test Limits and type of cable.

Test results on the screenshots are for illustration purposes only and not to be taken as reference values.

4.2.1.1 The Tone Generator mode

Starting from v8.0, unless when performing a Single-Ended cable test, WireXpert will automatically switch to Tone Generator mode when only one end is connected and the **[AUTOTEST]** button is pressed. WireXpert will be able to perform audible cable detection when paired with a Softing CT15 Tone Generator.

When faced with multiple unlabeled open-ended cables, connect one end of the cable to WireXpert. Point the CT15 Tone Generator to the other end of the cables. CT15 will produce a different tone when the cable that is connected to WireXpert is detected.

The Tone Generator mode can also be triggered by pressing the **[TOOLS]** button → **Tone Generator**.

4.2.2 The [SETUP] button



The **[SETUP]** button provides setting options necessary to conduct an AUTOTEST and configure the device.

These options include –

4.2.2.1 Quick Setup

Quick Settings provides quick selection using predefined TIA (CAT 5e/6/6A) and ISO (Class D/E/EA/F/FA) configurations for UTP/FTP cables. WireXpert will detect if Channel or Permanent Link adapter is used and changes its test limits automatically.



4.2.2.2 Test Settings

Test Settings provides results-oriented configurations necessary to perform an AUTOTEST including; -

4.2.2.2.1 Test Limit

Choose from a list of standards to determine the performance criteria in a given category or class. Three of the most commonly used limits will be listed in the “Recent Limit” list.

Press the **[SETUP]** button → **Test Settings** → **Test Limits** to choose from a list of commonly used limits. Three recently used limits will be on top of the list.



Test Limits update

Starting from v7.3, the following limits has been added into WireXpert

- TIA – Cat 8 Channel
 - 22-23 AWG
 - 24 AWG
 - 26 AWG
- TIA
 - Cat 5e MPTL (Modular Plug Terminated Link)
 - Cat 6 MPTL
 - Cat 6A MPTL
- End-to-End (E2E)
 - ISO – Five Connections Class D E2E Link
 - ISO - Five Connections Class E E2E Link
 - ISO – Four Connections Class D E2E Link
 - ISO – Four Connections Class E E2E Link
 - ISO - Three Connections Class D E2E Link
 - ISO – Three Connections Class E E2E Link
 - ISO – Two Connections Class D E2E Link
 - ISO – Two Connections Class E E2E Link

Fehler! Verwenden Sie die Registerkarte 'Start', um Heading 1 dem Text zuzuweisen, der hier angezeigt werden soll.

- Application Standards
 - 1000 Base-TX
 - 100 Base-TX
 - 10 Base-T
- Cenelec EN 50173 Class FA Channel
- Taiwan EL-3600-9 Standards
- China GB_T 50312-2016 Standards

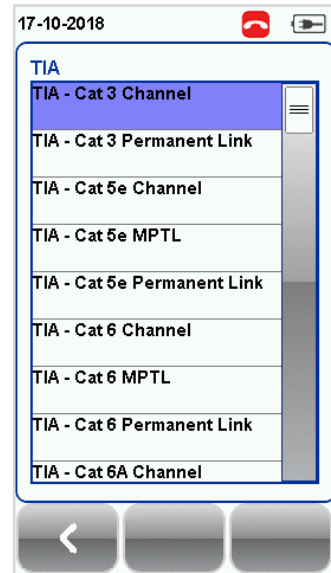
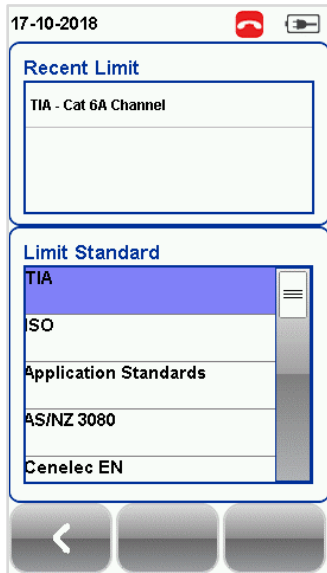
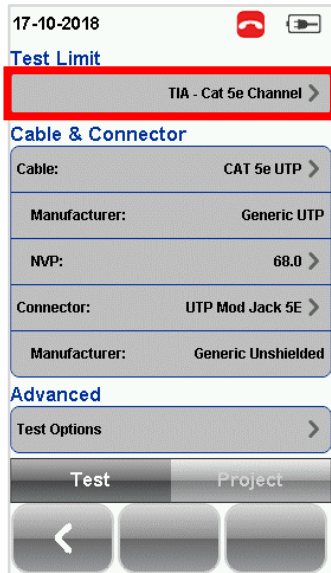

Standard test limit list

4.2.2.2.2 Cable

Choose from a list of cable manufacturer for more specific test parameters. If unsure of manufacturer, choose **[Generic UTP]** or **[Generic Shielded]** or **[Customized Cable]** to create custom cable.

Press the **[SETUP]** button → **Test Settings** → **Cable Manufacturer** to choose from a list of cable manufacturers. If unsure of manufacturer, choose **[Generic UTP]** or **[Generic Shielded]**, or **[Customized Cable]** to create custom cable.

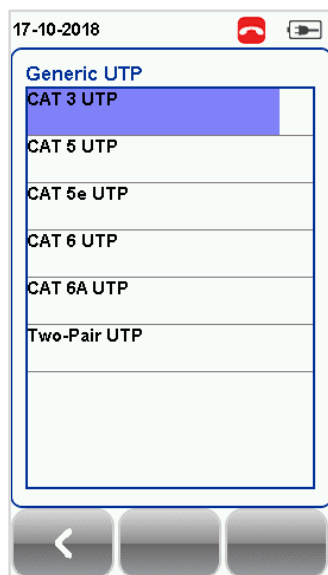
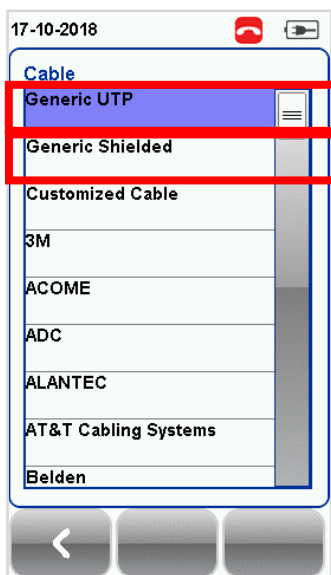

Generic UTP cable list



Generic Shielded cable list

Customized Cable

Click **[Add]** to add or **Manage** → **[Delete]** to remove customized cable(s) from the customized cable list.

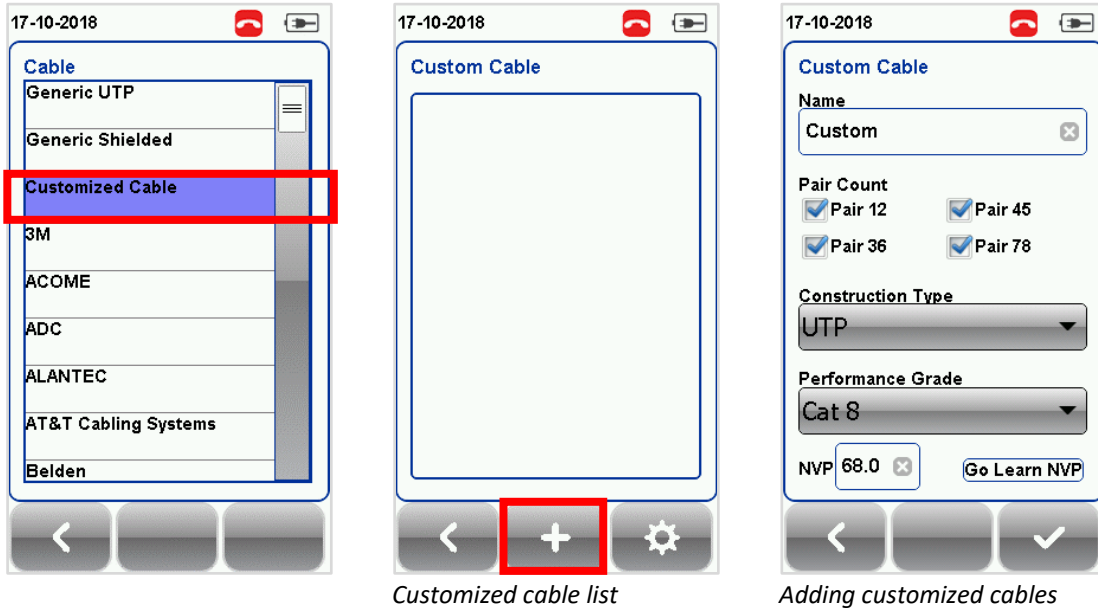

When creating customized cable, determining the cable name, number of pairs, construction type, performance grade(S/FTP) and cable's NVP is required.



WireXpert introduces the **[Manage]** button on version 7.0 firmware. **[Manage]** enables multiple saved items such as sites, operators, customized cables, customized connectors and results to be selected and deleted simultaneously.

4.2.2.2.3 NVP

Determine the Nominal Velocity of Propagation (NVP) value of the cable. The NVP factor is required to determine the accurate length of the cable run to be measured. Based on this constant value, the WireXpert performs its TDR calculations. Please see the cable's data sheet for the specific value of the cable type in use.

If the specific NVP value is unknown, press the **[TOOLS]** button → **Learn NVP** to determine the value using the predefined cable run of at least 30 meters or 100 feet.

4.2.2.2.4 Connector

Press the **[SETUP]** button → **Test Settings** → **Connector Manufacturer** to choose from a list of connector manufacturers. If unsure of manufacturer, choose **[Generic Unshielded]** or **[Generic Shielded]**, or **[Customized Connector]** to create custom connector.

Click **[Add]** to add or **Manage** → **[Delete]** to remove customized connector(s) from the customized connector list.

Fehler! Verwenden Sie die Registerkarte 'Start', um Heading 1 dem Text zuzuweisen, der hier angezeigt werden soll.

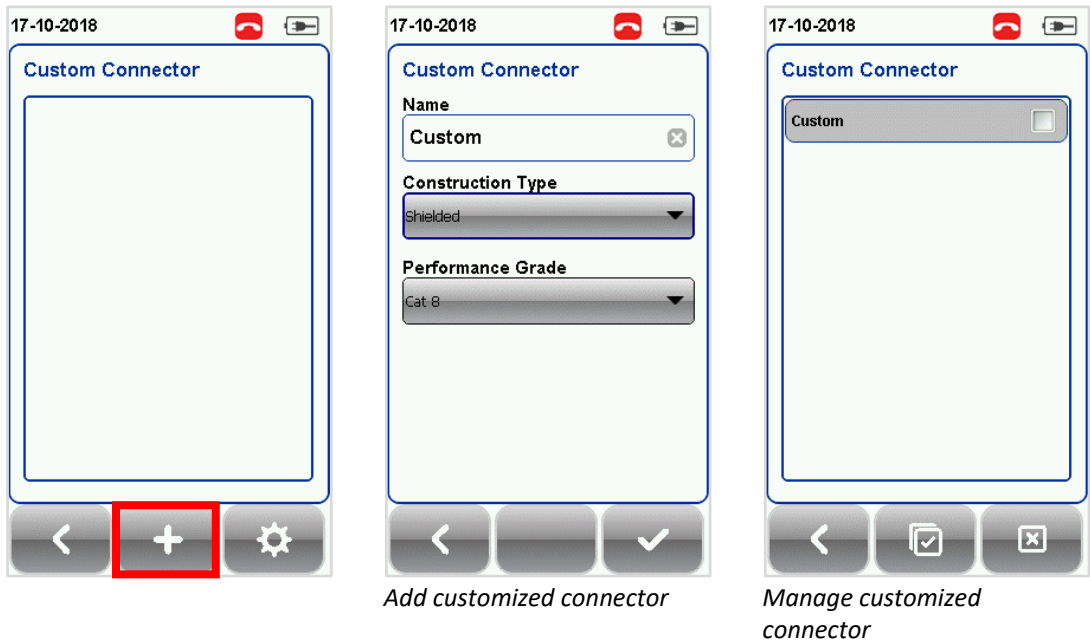

4.2.2.2.5 Advanced Test Options

Advanced Test Options determines how the test will be conducted and results will be displayed.

General

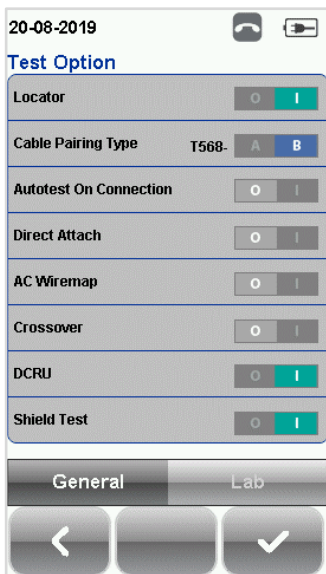

- Locator – If enabled, WireXpert will display NEXT and Return Loss (RL) fault information in an AUTOTEST result. Enabled by default.
- Cable Pairing Type – Choose T568A or T568B copper cable wiring standard. “B” is selected by default. Option will be disabled when a TERA Channel or TERA Link adapter is connected to WireXpert.

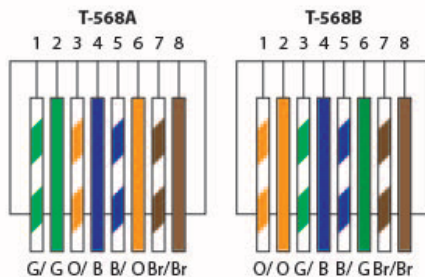

- AUTOTEST On Connection – If enabled, WireXpert will perform an AUTOTEST automatically when LOCAL is connected to the REMOTE unit. Disabled by default.
- Direct Attach – If enabled, WireXpert will perform Direct Attach copper installation test. Attach a Permanent Link adapter to the LOCAL and a Patch Cord adapter to the REMOTE unit to perform this test. Connect the LOCAL unit to patch panel and REMOTE to field terminated end. Disabled by default.

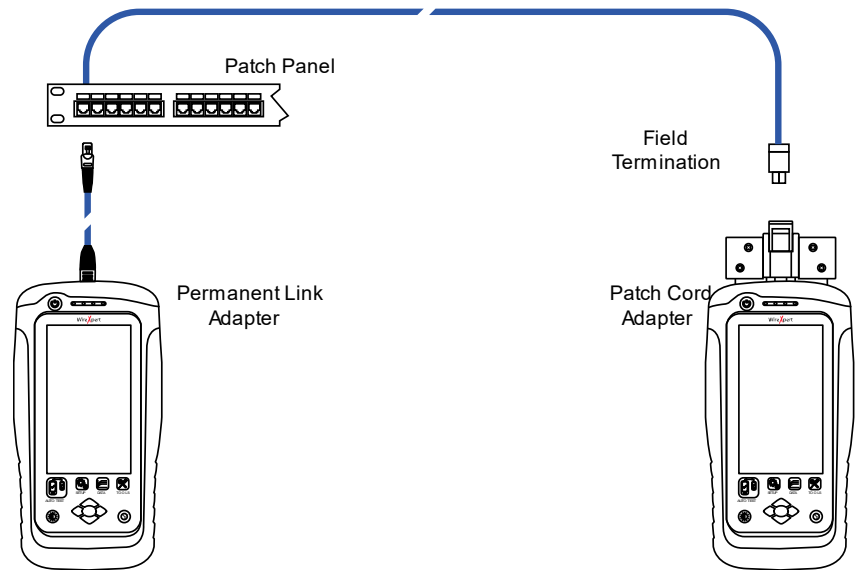

- AC Wire map – If enabled, WireXpert is able to measure test runs with Power over Ethernet (PoE) midspan devices in between. The WireXpert supports cable runs with IEEE 802.3 af and 802.3 at injectors. Disabled by default. Option will be disabled when Shield Test option is enabled.
- Crossover – If enabled, depending on the limits selected, WireXpert is able to test one or more of the follow crossover cable. Disabled by default.

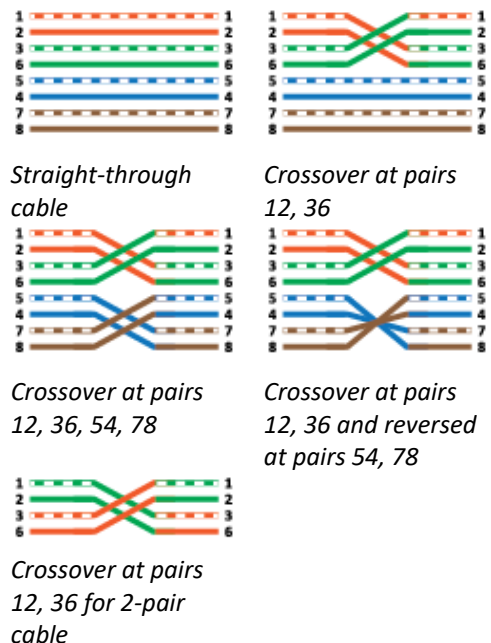
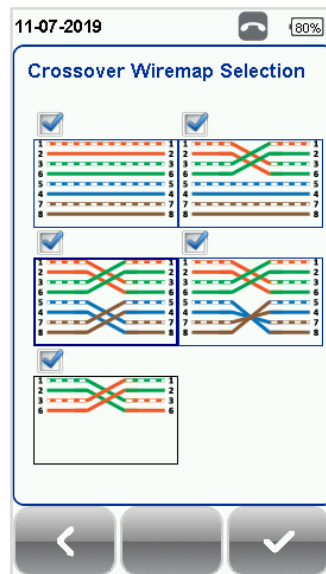

- DCRU – If enabled, WireXpert will perform additional DC resistance unbalance test measurements between and within each pair in accordance with TIA and IEC specifications, on top of the AUTOTEST parameters required in a Channel or Permanent Link. Disabled by default. Option is only available with CAT6A+ adapters.
- Shield Test – If enabled, WireXpert will perform shield integrity test to identify if a shield is present and connected between both ends on the actual cable under test. Disabled by default. Option is only

available with CAT6A+ adapters. Option will be disabled when AC Wiremap option is enabled.



Note

Crossover can only be selected by selecting a test limit from **Test Settings** → **Test Limit** → **Application Standards**. Disabled by default.

Crossover wiremap selections will only be available for the applicable limits as follows:

	<i>Straight-through cable</i>	<i>Crossover at pairs 12, 36</i>	<i>Crossover at pairs 12, 36, 54,78</i>	<i>Crossover at pairs 12, 36 and reversed at pairs 54, 78</i>	<i>Crossover at pairs 12, 36 for 2-pair cable</i>
1000BASE-T	Yes	No	No	Yes	No
1000BASE-TX	Yes	No	Yes	No	No
100BASE-TX	Yes	Yes	Yes	Yes	Yes
10BASE-T	Yes	Yes	Yes	Yes	Yes



User Guide

Refer “User Manual – CAT 6A+ Adapters” for more information.

Lab

Laboratory use only. Password is required to access this section. Please contact your local WireXpert Vendor for more information.

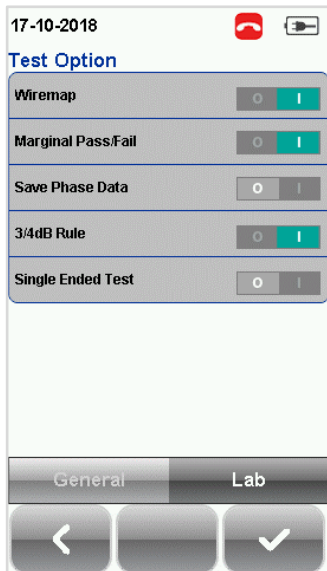

- Wiremap Test – If enabled, WireXpert will not continue with the AUTOTEST process if a wire map FAIL is detected. Enabled by default.
- Marginal Pass/Fail –If enabled, WireXpert will display marginal pass (PASS*) and marginal fail (FAIL*) results. A marginal test result is obtained when its margin is smaller than the accuracy specification for the test parameter. Enabled by default.
- Save Phase Data – If enabled, WireXpert will generate information for phase data plot generation. Export saved results to CSV format using eXport software to obtain phase data. Impedance plot will be displayed on eXport. Disabled by default.
- 3/4 dB Rule – If enabled, WireXpert will ignore Return Loss (RL) measurements if the Insertion Loss (IL) is <3dB and NEXT measurements if the IL is <4dB. Disabled by default.
- Single Ended Test – If enabled, WireXpert will be able to perform a cable test to obtain only Length & Delay, RL, NEXT and PS-NEXT results without a REMOTE unit. Single Ended Test can only be performed using a

Custom Limit. Refer to “User Guide – Custom Copper Limit” for more information. Disabled by default.

4.2.2.3 Project Settings

Project Settings provides non-results-oriented configurations before performing an AUTOTEST.

4.2.2.3.1 Site

To add a site,

1. Press the **[SETUP]** button → **Project Settings** → **Site** to begin adding a new site.
2. Click the **[Add]** button to add a new site.
3. Enter a Site Name. Site Name is a required field. Test results and label source will be saved under the created Site.
4. Site Address and Site Notes are optional fields, but they provide additional information of the site.
5. Press **[OK]** to save site and proceed.

By default, WireXpert creates an “UNSPECIFIED” site for default saving if new sites are not created.



To delete a saved site,

1. Press the **[Manage]** button.
2. Select site(s) and press the **[Delete]** to delete site(s).



WireXpert introduces the **[Manage]** button on version 7.0 firmware. **[Manage]** enables multiple saved items such as sites, operators, customized cables, customized connectors and results to be selected and deleted simultaneously.

4.2.2.3.2 Operator

To add an operator,

1. Press the **[SETUP]** button → **Project Settings** → **Operator** to begin adding an operator.
2. Click the **[Add]** button to add a new operator.

Fehler! Verwenden Sie die Registerkarte 'Start', um Heading 1 dem Text zuzuweisen, der hier angezeigt werden soll.

3. Enter Operator Name.
4. Press **[OK]** to save site and proceed.

By default, WireXpert creates an “UNSPECIFIED” operator for default saving if new operators are not created.



To delete a saved operator,

1. Press the **[Manage]** button.
2. Select operator(s) and press the **[Delete]** to delete operator(s).

4.2.2.4 Label Source

Press the **[SETUP]** button → **Test Settings** → **Label Source** to choose from a list of schemes.

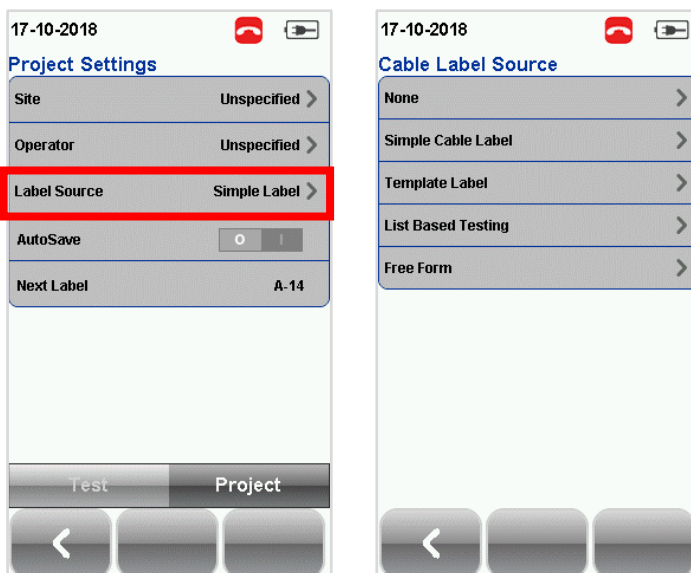

None

Manual input of label names is required for every saving of result.

Simple Label

Provides simple numeric increments to a prefix. To configure the simple label scheme:

1. Label Name - Enter desired Prefix (e.g. Office, Company X) for every label.
2. Start Value - Set a numeric start value (e.g. 1, 33, 245) for incremental counts.

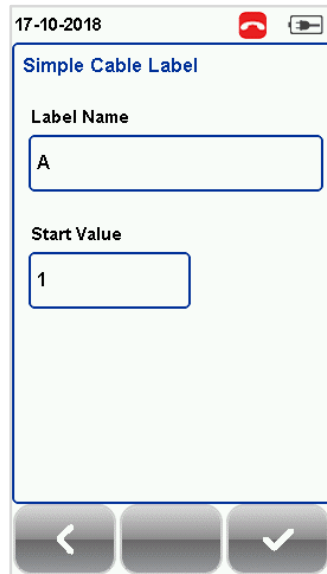

The screenshot shows a mobile application interface titled "Simple Cable Label". At the top, there is a date "17-10-2018" and a red call icon. Below the title, there are two input fields: "Label Name" with the value "A" and "Start Value" with the value "1". At the bottom, there are three navigation buttons: a back arrow, a central button, and a checkmark button.

TIA-606-A Class 1 (Single Room Horizontal Link)

TIA-606-A Class 1 standard labelling scheme mainly used to support labelling for a building or premises that is served in a single equipment room or a horizontal cross-connect.

The default "1A-A1" generally refers to "Floor + Tel Room – Panel + Port".

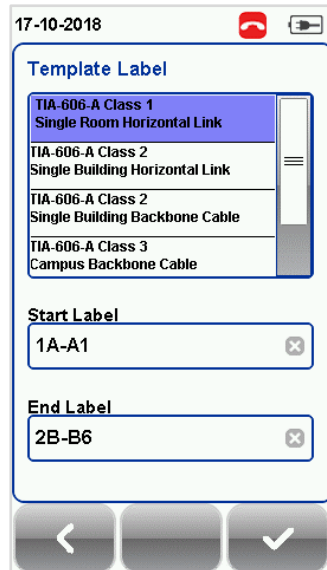

The screenshot shows a mobile application interface titled "Template Label". At the top, there is a date "17-10-2018" and a red call icon. Below the title, there is a list of template options: "TIA-606-A Class 1 Single Room Horizontal Link" (highlighted), "TIA-606-A Class 2 Single Building Horizontal Link", "TIA-606-A Class 2 Single Building Backbone Cable", and "TIA-606-A Class 3 Campus Backbone Cable". Below the list, there are two input fields: "Start Label" with the value "1A-A1" and "End Label" with the value "2B-B6". At the bottom, there are three navigation buttons: a back arrow, a central button, and a checkmark button.

TIA-606-A Class 2 (Single Building Horizontal/Single Building Backbone Cable)

TIA-606-A Class 2 standard labelling scheme mainly used to support labelling of infrastructure with one or more telecommunication spaces in a single building.

The default "1A-A1" for Horizontal Link generally refers to "(1) Floor + (A) Tel Room – (A) Panel + (1) Port".

The default "1A/1B-" for Backbone Cable generally refers to "(1) Tel Room 1 Floor + (A) Tel Room 1 Name / (1) Tel Room 1 Floor + (B)Tel Room 2 Name" followed by - "Backbone Cable . Cable"

Fehler! Verwenden Sie die Registerkarte 'Start', um Heading 1 dem Text zuzuweisen, der hier angezeigt werden soll.

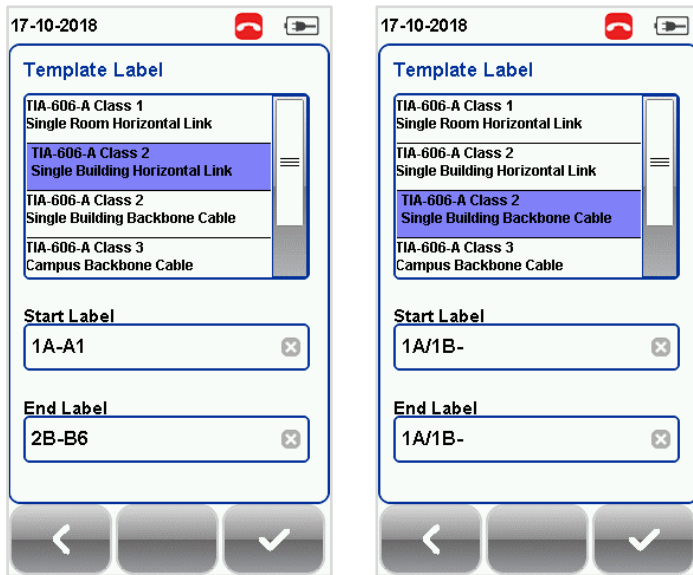

TIA-606-A Class 3 (Campus Backbone Cable)

TIA-606-A Class3 standard labelling scheme mainly used to support labelling for multiple buildings in a single site.

The default “A-1A/A-1A-” generally refers to “(A)Building 1 Name - (1) Tel Room 1 Floor + (A) Tel Room 1 Name / (A) Building 2 Name – (1) Tel Room 2 Floor + (A) Tel Room 2 Name” followed by - “Backbone Cable. Cable”

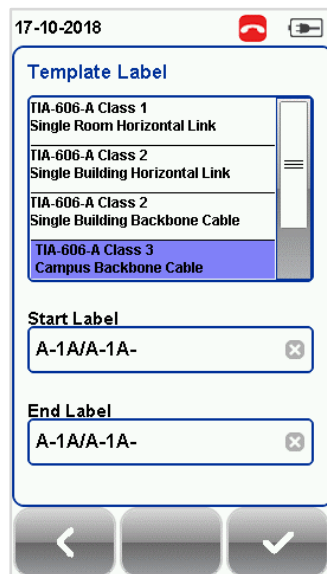

List Based Testing

List based testing allows creation of label list in the eXport software on PC and then bring the list to WireXpert. It further allows easy selection of labels from the list to help technician select the cables to be tested quickly. This testing method is carefully optimized for typical test work-flow, and it significantly improves productivity.

1. Insert USB flash drive to USB port on WireXpert.
2. Device will automatically detect USB flash drive.

3. Select **[Label List]**.
4. Select the custom label list(s) to be copied from the USB flash drive.
5. Select **[Copy label files]** to proceed.
6. Click **[OK]**.

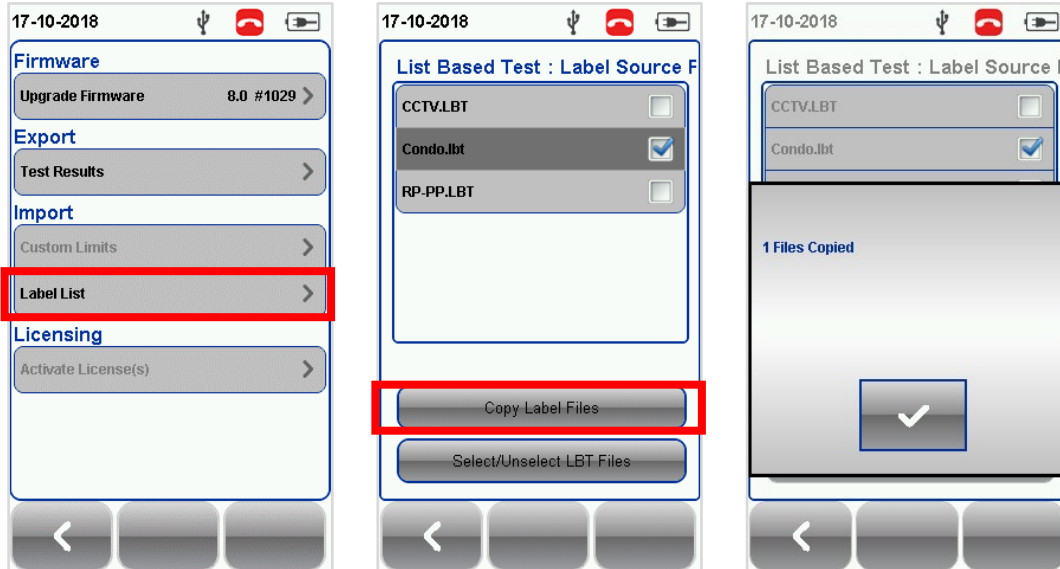

7. Press the **[SETUP]** button → **Project Settings** → **Label Source** → **List Based Testing**
8. Select label source file and click **[OK]** to continue.



User Manuals

Refer “User Manual – eXport” for more information on generating list-based labels.

9. Press the **[AUTOTEST]** button to display the loaded cable list.
10. Select label from list to begin AUTOTEST.
11. WireXpert will automatically save a PASS result and return to the list or allows you to save or conduct a re-test for a FAIL result manually.
12. Select a tested label to view the results. A green result indicates a PASS and a red result indicates a FAIL test. A re-test can be conducted by pressing **[Retest]**.
13. Press the **[AUTOTEST]** button to return to the list.

Free Form

Free Form provides simple numeric increments to 2 or more prefix.

The default start “A-1” and end “B-5” labels will generate labels “A1 to A5 and B1 to B5”.

Fehler! Verwenden Sie die Registerkarte 'Start', um Heading 1 dem Text zuzuweisen, der hier angezeigt werden soll.

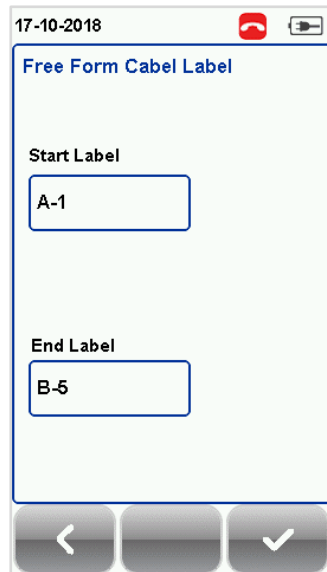

4.2.2.4.1 AutoSave



Enable option for WireXpert to automatically save every PASS result only. Rectify or manually save FAIL results.

4.2.2.5 System Settings

4.2.2.5.1 Length Unit



Press the **[SETUP]** button → **System Settings** → **Settings 1** → **Device Settings** → **Length Unit** to select the preferred length unit to be displayed. Feet (FT) and Meters (M) are available.

4.2.2.5.2 Plot Y-axis Direction



Press the **[SETUP]** button → **System Settings** → **Settings 1** → **Device Settings** → **Plot Y-axis Direction** to select the how the plot's Y-axis will be display. Normal and Inverted Y-axis are available.

4.2.2.5.3 Device Type



Press the **[SETUP]** button → **System Settings** → **Settings 1** → **Device Settings** → **Device Type** to switch a LOCAL unit to REMOTE, or vice versa.

4.2.2.5.4 Sleep and Auto Power-off Interval

For Sleep Interval,

Press the **[SETUP]** button → **System Settings** → **Settings 1** → **Sleep Interval** to select the idle duration before WireXpert enters the sleep (power saving) mode.

For Auto Power-off Interval,

Press the **[SETUP]** button → **System Settings** → **Settings 1** → **Auto Power-Off Interval** to select the idle duration before WireXpert performs an automatic shutdown.

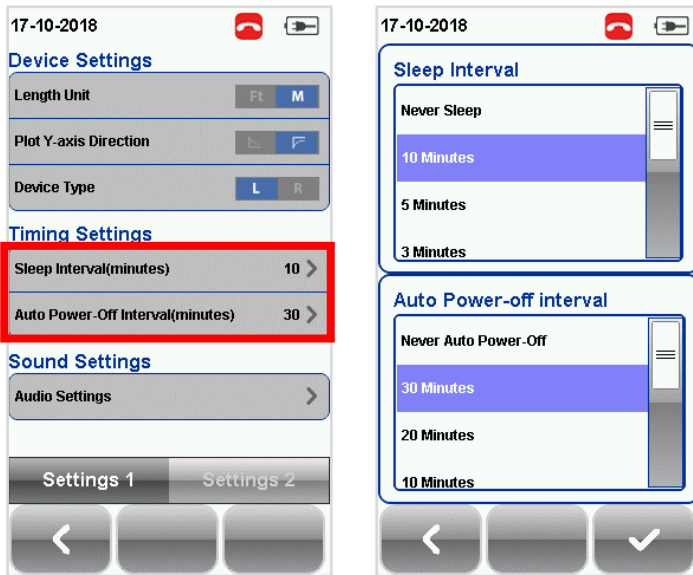

4.2.2.5.5 Audio Settings

Press the [SETUP] button → System Settings → Settings 1 → Audio Settings to configure various audio options for WireXpert.

- Touch Click – Enable option to trigger clicking sound options on screen touch.
- Speaker & Tone – Enable option to trigger system sound options, e.g., boot up.
- Voice Prompt – Enable option to trigger system vocal notifications on action.
- Volume Control – Adjust for audio loudness.

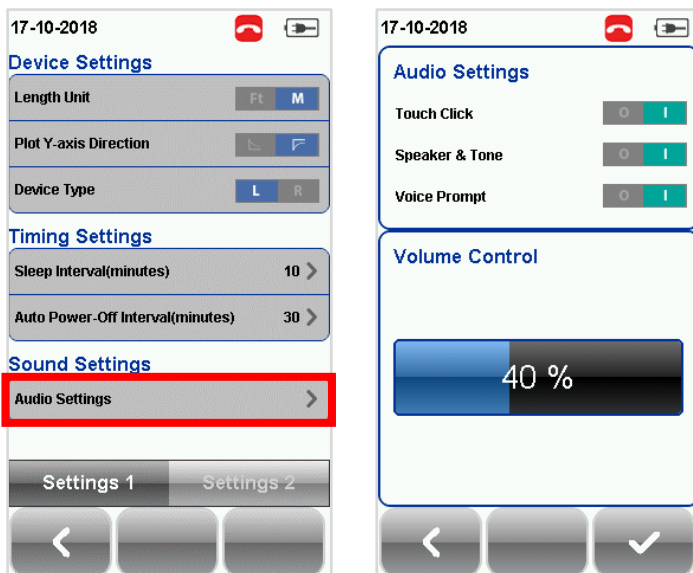

4.2.2.5.6 Date and Time

Press the [SETUP] button → System Settings → Settings 2 → Date & Time to configure date, time and display format.

Fehler! Verwenden Sie die Registerkarte 'Start', um Heading 1 dem Text zuzuweisen, der hier angezeigt werden soll.

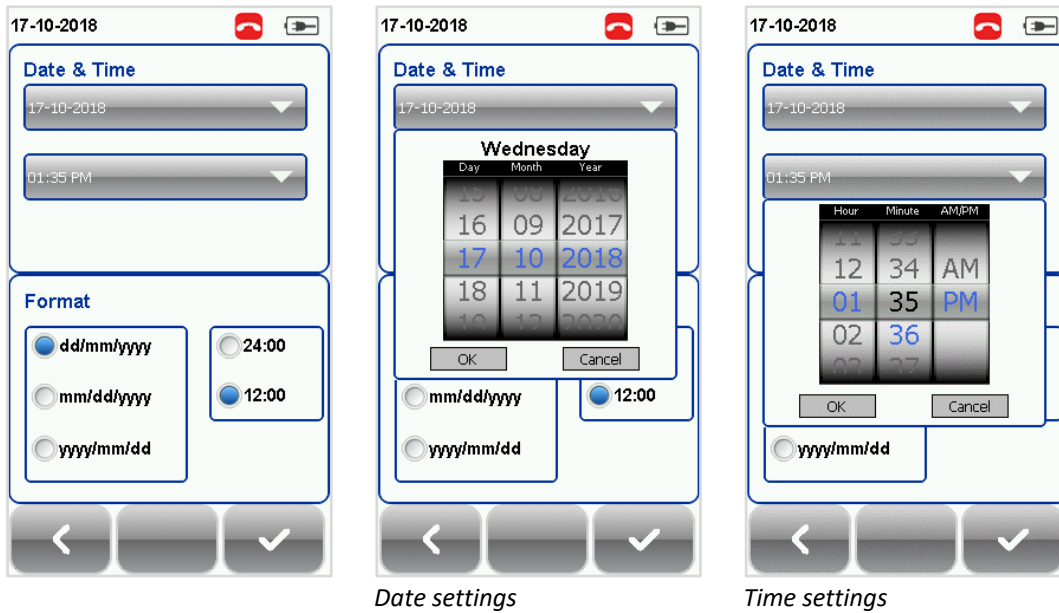

4.2.2.5.7 Language

Press the [SETUP] button → System Settings → Settings 2 → Language to select preferred display language.

4.2.2.5.8 Storage

Press the [SETUP] button → System Settings → Settings 2 → Storage to view available storage space on WireXpert and USB flash drive if inserted.

Read USB flash drive by clicking the USB icon if prompt did not appear or closed after inserting USB flash drive.

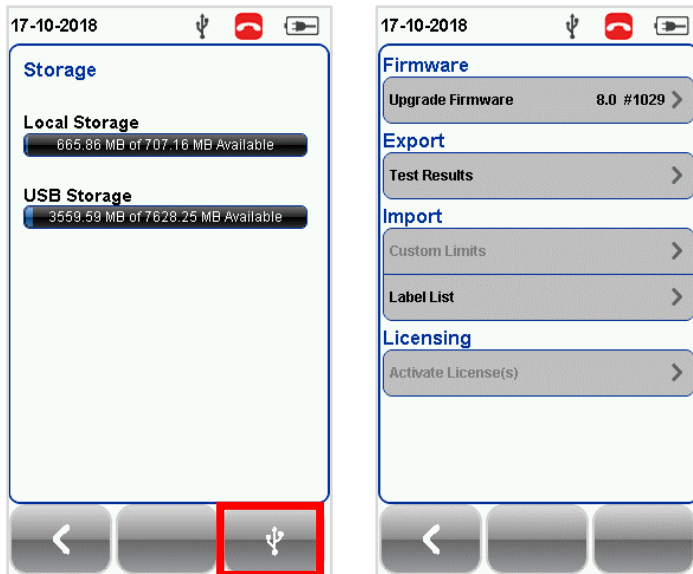

Select **Upgrade Firmware** to upgrade current firmware version. Please export all results before performing an upgrade to prevent loss of data.

Select **Test Results** to export Sites to an USB drive. This may take a while depending on the number of test results that are currently saved in the Site(s).

Select **Custom Limits** to import custom limit files from an USB drive. Ensure custom limit files are stored in the “CustomLimits” folder in the USB drive before inserting to WireXpert. Select custom limit file(s) to be loaded and select **[Copy Custom Limits]**.



User Guides

Refer “User Guide – Copper Custom Limits” for more information on creating and using custom limits.

Select **Label List** to import label list created with eXport PC software using an USB drive. Ensure custom limit files are stored in the “Label List” folder in the USB drive before inserting to WireXpert. Select label list file(s) to be loaded and select **[Copy Label files]**.



User Manuals

Refer “User Manual – eXport” for more information on generating list-based labels.

Select **Activate License(s)** to load license(s) to upgrade WireXpert 500 to WireXpert 500-plus or WireXpert 4500. Ensure custom limit files are stored in the “Features” folder in the USB drive before inserting to WireXpert. Select license key(s) to be activated and select **[Activate License(s)]**. License(s) are unique to devices and cannot be transferred between units.



User Guides

Refer “User Guide – License Upgrade” for more information on upgrading WireXpert through licensing.

4.2.2.5.9 Battery

Press the **[SETUP]** button → **System Settings** → **Settings 2** → **Battery** to view battery level. Battery levels of LOCAL and REMOTE will be displayed if units are connected.

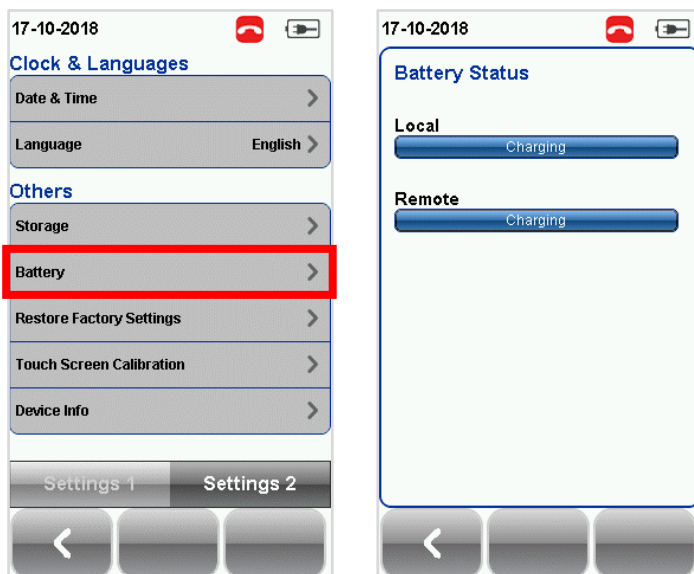

Fehler! Verwenden Sie die Registerkarte 'Start', um Heading 1 dem Text zuzuweisen, der hier angezeigt werden soll.

4.2.2.5.10 Restore Factory Settings

Press the [SETUP] button → System Settings → Settings 2 → Restore Factory Settings to restore WireXpert to factory settings. Click [OK] to begin restoration.

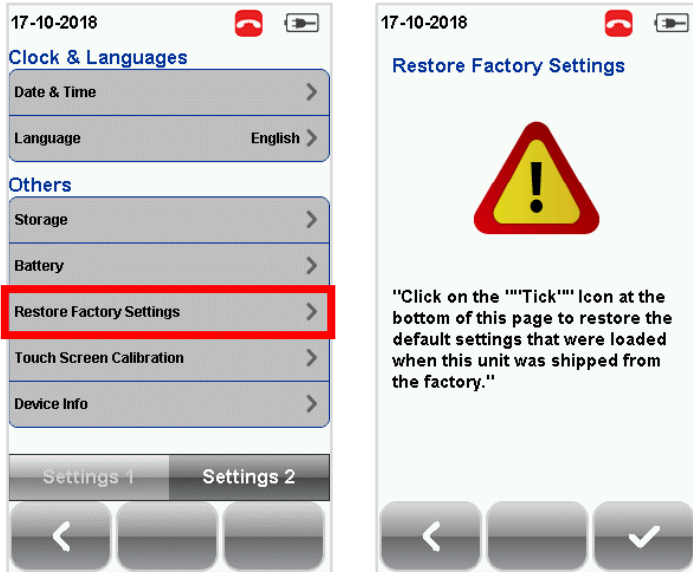

CAUTION

Restoring WireXpert to default settings is an irreversible action. All user defined settings and stored test results will be erased and cannot be recovered.

4.2.2.5.11 Touch Screen Calibration

Press the [SETUP] button → System Settings → Settings 2 → Touch Screen Calibration to re-adjust mechanical alignments of the touch screen. Follow on-screen instructions to begin calibration. Screen can only be exited after the screen calibration is completed.

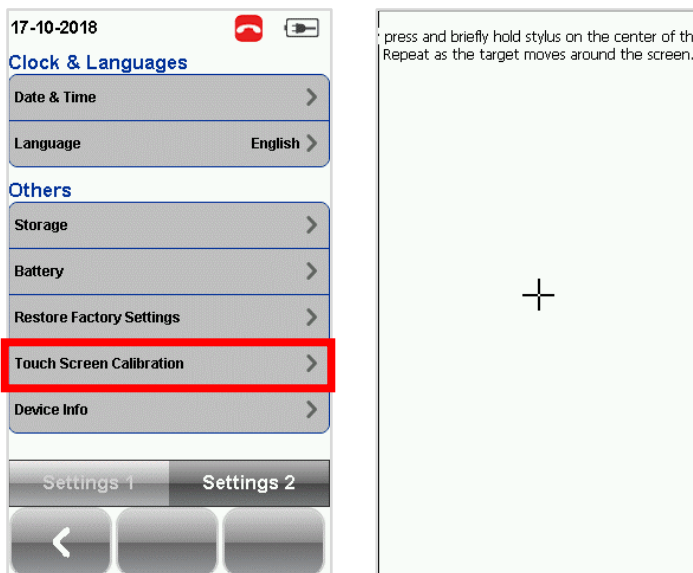

4.2.2.5.12 Device Info

Press the [SETUP] button → System Settings → Settings 2 → Device Information to check the device and probe serial numbers, software and hardware version numbers, device last calibrated date and probe test count.

Click on the **[Device Info]** button for more information on the firmware.

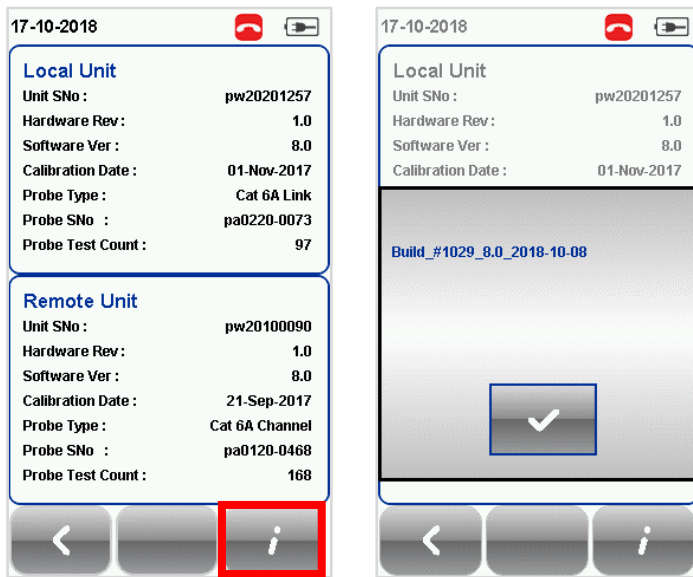

Device firmware build version



Note

To ensure accurate test results, it is recommended to have WireXpert units calibrated every year. Contact vendor for more information.

4.2.3 The **[DATA]** button



The **[DATA]** button provides archive and data management ability to saved sites and test results. Saved test results can be renamed or deleted in this option. Select **Copper** → **[View]** to view saved copper test results. Saved copper test results can only be viewed in copper test mode.

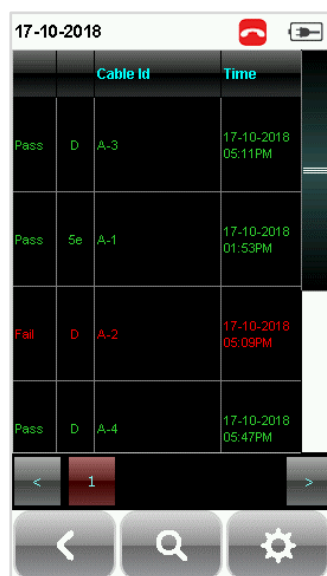
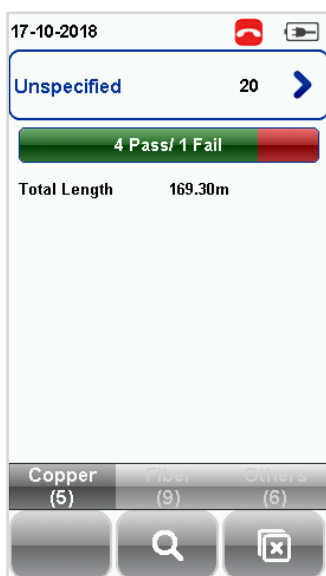

View Results

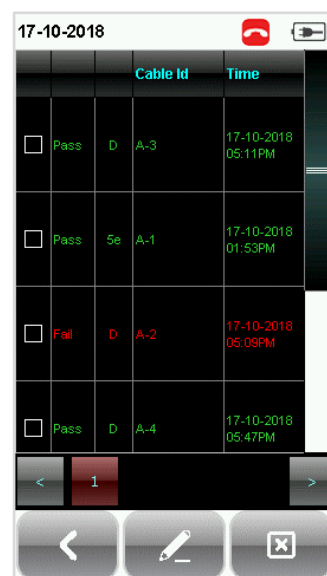

Manage Results



CAUTION

Deleting a site will also delete its containing test results.

4.2.4 The [TOOLS] button



The **[TOOLS]** button provides advanced options for in-depth troubleshooting and expert WireXpert users. These options include; -



Requires:
LOCAL and REMOTE¹

Set Reference – Performs loss compensation through calculation from setting of referencing point.



Requires:
LOCAL or REMOTE²

Length & Delay – Performs a test to determine the length and propagation delay of each pair using the NVP value programmed by the user.



Requires:
LOCAL and REMOTE

Wiremap – Verifies end-to-end wire mapping of cable.



Requires:
LOCAL and REMOTE

Learn NVP – Performs a test to determine the NVP of the cable using the length value³ programmed by the user.



Requires:
LOCAL or REMOTE

Reset Probe – Resets Permanent Link adapter usage count once a new link cord is in place.



Requires:
LOCAL or REMOTE

About – Displays worldwide contact and End User License Agreement (EULA) information.



Requires:
LOCAL and REMOTE

Factory Calibration – Performs device calibration and configurations. For Service Centre use only.



Requires:
1. LOCAL or REMOTE
2. Tone Generator[#]

Tone Generator – Detects far-end of open-ended cables when paired with Tone Generator. See "[Tone Generator mode](#)" for more information.



Requires:
1. LOCAL & REMOTE
2. License key(s)[#]

Licensing – Performs device upgrade from WireXpert 500 to WireXpert 500+ or/to WireXpert 4500.



Requires:
1. LOCAL only
2. Wi-Fi dongle[#]

Wifi – Enables WireXpert to connect to the Wi-Fi to perform eXport Cloud features.



Requires:
1. LOCAL only
2. eXport Cloud[#]

eXport Cloud – Enables WireXpert to download List Based Testing (*.LBT) and upload project site (*.WSD) files to the eXport Cloud platform. Active network connection is required.



Note

¹ LOCAL and REMOTE - Action can only be performed when both LOCAL and REMOTE units are connected.

² LOCAL or REMOTE - Action can be performed using either the LOCAL or REMOTE unit. End-to-end connection is not required.

³ 30 meters (100 feet) cable length is at least required to get a valid NVP value.

[#] Optional purchase required for feature. Contact local vendor for more information.



User Manuals

Refer “User Manual – eXport Cloud” for more information on installing and using eXport Cloud.



User Manuals

Refer “User Guide – License Upgrade” for more information on upgrading WireXpert 500 to WireXpert 500+ or/to WireXpert 4500.

5 Setting Reference

It is necessary to perform a set reference measurement if the LOCAL and REMOTE units are being paired for the first time. If there is a mismatch in firmware versions or a set reference has not been performed, AUTOTEST will be denied, until these conditions are corrected. Please also verify before testing that calibrations are not expired.



Note

Diagrams and images used are for illustration purposes only and do not represent suggested test values. Reference and test values vary to usage and condition.

To set reference,

1. Connect a Permanent Link adapter to the LOCAL unit.
2. Connect a Channel adapter to the REMOTE unit.
3. Connect the 2 units together using the patch cord provided in the kit.
4. Press the **[TOOLS]** button → **Set Reference**

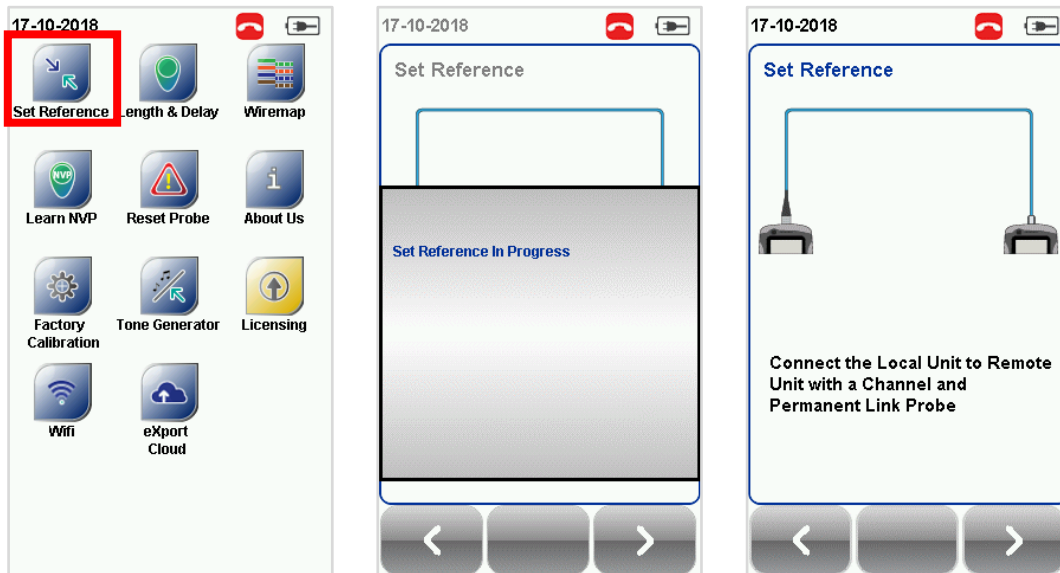

5. Set Reference will fail in the event of-
 - Adapter probe mismatch, i.e., two channel or permanent link adapters
 - Firmware version mismatch between LOCAL and REMOTE units
 - No connection between LOCAL and REMOTE units

6 Configuring an AUTOTEST

6.1 Setting up WireXpert

After configuring the system settings, follow these steps to set up an AUTOTEST.

1. Press the **[SETUP]** button → **Project Settings**
 - a. **Site** – Create or select a Site
 - b. **Operator** – Create or select an Operator
 - c. **Label Source** – Select cable labelling scheme. Load labels from USB flash drive if using List Based Testing (LBT).
 - d. **AutoSave** – Enable option for WireXpert to auto save every PASS result.
2. Press the **[SETUP]** button → **Quick Setup** to select pre-defined test limit settings using matching generic UTP/FTP cable and connector.
3. Manual Setup – Press the **[SETUP]** button → **Test Settings**
 - a. **Test Limit** – Select a test limit
 - b. **Cable** – Create a custom or select cable from list. Select **[Generic]** if unsure.
 - c. **Connector** - Create a custom or select connector from list. Select **[Generic]** if unsure.
 - d. **Test Options** → **General**
 - i. **Locator** – Enable option to display the worst NEXT and Return Loss (RL) fault information in an AUTOTEST result. Default has been set to OFF.
 - ii. **Cable Pairing Type** – Select if cable under test is paired using the T568-A or T568-B standard. Option will be disabled when a TERA Channel or TERA Link adapter is connected to WireXpert.

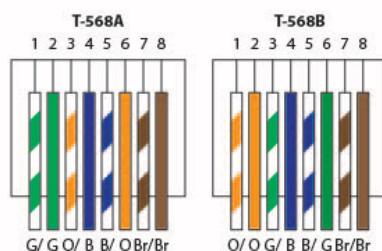

- iii. **Autotest on Connection** – Enable option to perform AUTOTEST on, i.e., as soon as the connection between LOCAL and REMOTE units is established. Default option has been set to OFF.
- iv. **Direct Attach** – Enable option only if performing Direct Attach installation test. Default option has been set to OFF.
- v. **AC Wire map** – Enable option to bypass testing DC parameters. Default option has been set to OFF.
- vi. **Crossover** – Enable option and select wiremap(s) if cable under test is a crossover cable. Option is only available when Application Standards is selected as the Limit Standard.

Default option has been set to OFF.

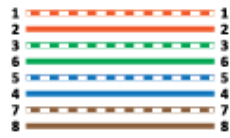

Straight-through cable



Crossover at pairs 12, 36, 54, 78



Crossover at pairs 12, 36 for 2-pair cable

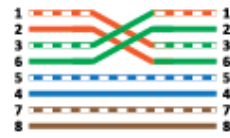

Crossover at pairs 12, 36

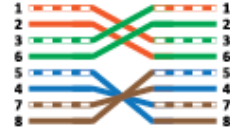

Crossover at pairs 12, 36 and reversed at pairs 54, 78

Please ensure you have the following components before conducting the test;

- WireXpert, LOCAL&REMOTE units (WX4500 or WX500-CU)

For Permanent Link Testing

- 2 x Permanent Link Adapter (WX_AD_6APL2)
- 2 x Patch Cord (WX_AC_6ALCORD2)

For Channel Testing

- 2 x Channel Adapter (WX_AD_6ACH2)



CAUTION

Do not connect WireXpert to a voltage source such as an active telephone jack. Excessive voltage will damage the units and the adapter and void the warranty.

6.2 Testing Guide for Permanent Link Testing

Permanent Link (PL) test is comprised of the connection from a patch panel to a telecommunication outlet (horizontal cabling) using Permanent Link test adapters at each end of the link under test.

1. Insert the Permanent Link adapters into the LOCAL and REMOTE units of the WireXpert.
2. Power ON WireXpert. Check that WireXpert is in Copper testing mode.
3. Set reference is required if the units are being paired for the first time.
4. Choose the Permanent Link limits and configure other settings if necessary.
5. Connect the LOCAL unit to the patch panel and REMOTE unit to the outlet using the patch cord provided.
6. Press the **[AUTOTEST]** button to begin AUTOTEST.

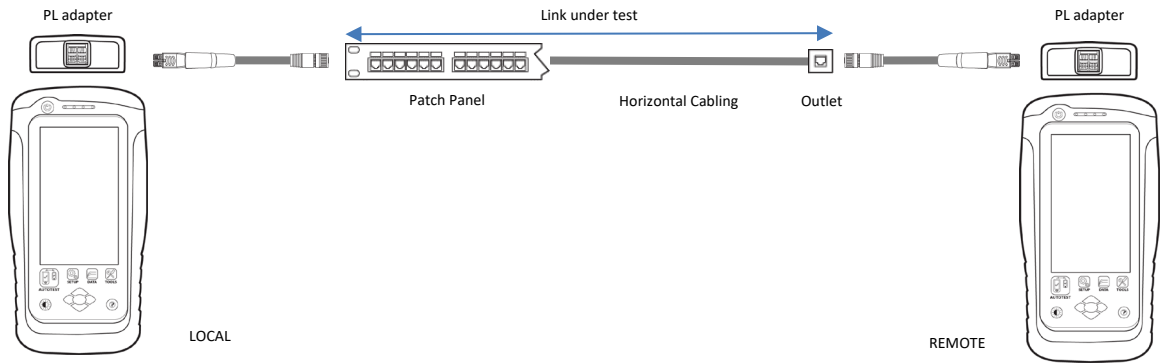

6.3 Testing Guide for Channel Testing

Channel (Ch) test is comprised of the connection from an active device (eg. Router) in a data rack, a telecommunication outlet (horizontal cabling) and the connecting patch cords at both ends using Channel test adapters at each end of the link under test. The recommended length for the patch cord from the patch panel and the outlet is 5m.

1. Insert the Channel adapters into the LOCAL and REMOTE units of the WireXpert.
2. Power ON WireXpert. Check that WireXpert is in Copper testing mode.
3. Set reference is required if the units are being paired for the first time. Refer to Chapter 2 on how to set reference.
4. Choose the Channel limits and configure other settings if necessary.
5. Connect the LOCAL unit to the patch panel and REMOTE unit to the outlet using the patch cord connected to be used.
6. Press the AUTOTEST button to begin AUTOTEST.

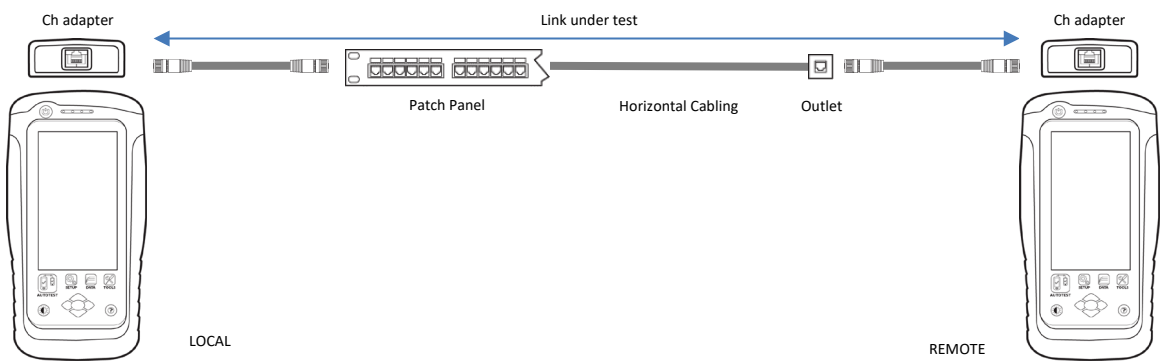

7 Performing an AUTOTEST

7.1 Understanding AUTOTEST

Press the **[AUTOTEST]** button once settings and limits have been selected. WireXpert will use the last configuration or factory settings to perform the AUTOTEST if new settings are not configured.

WireXpert will display summarized result with PASS or FAIL once AUTOTEST is completed. Press the **[View]** details button to view the comprehensive result or the **[Save]** button to save the results.

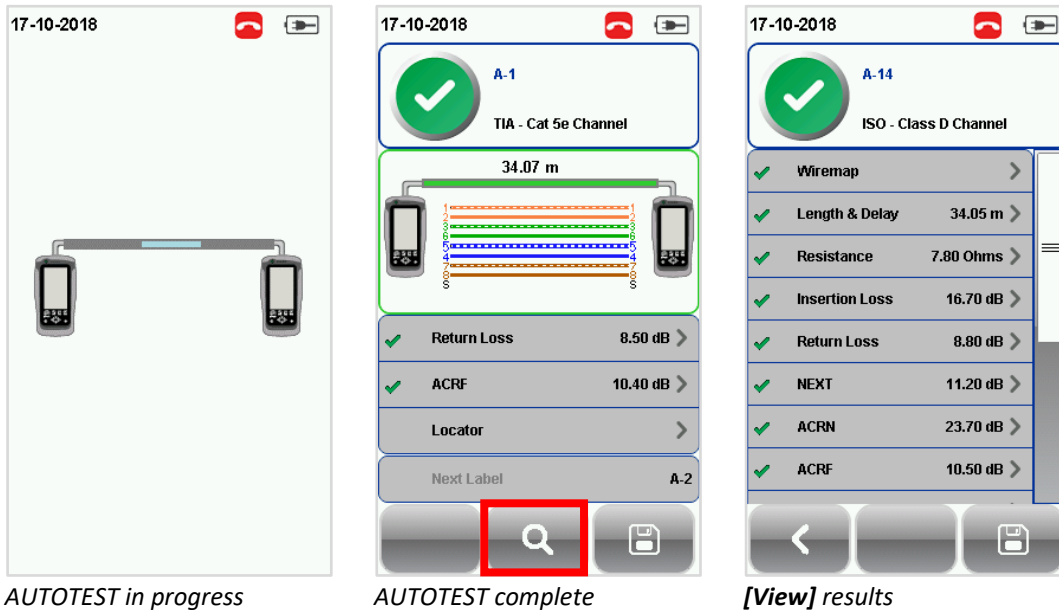

Click on the parameter to display a more comprehensive individual result.

In plot view, press the **[Worst Margin]** button to view the worst margin. Press again to view the **[Worst Value]** or press the **[Manage]** button for more options.

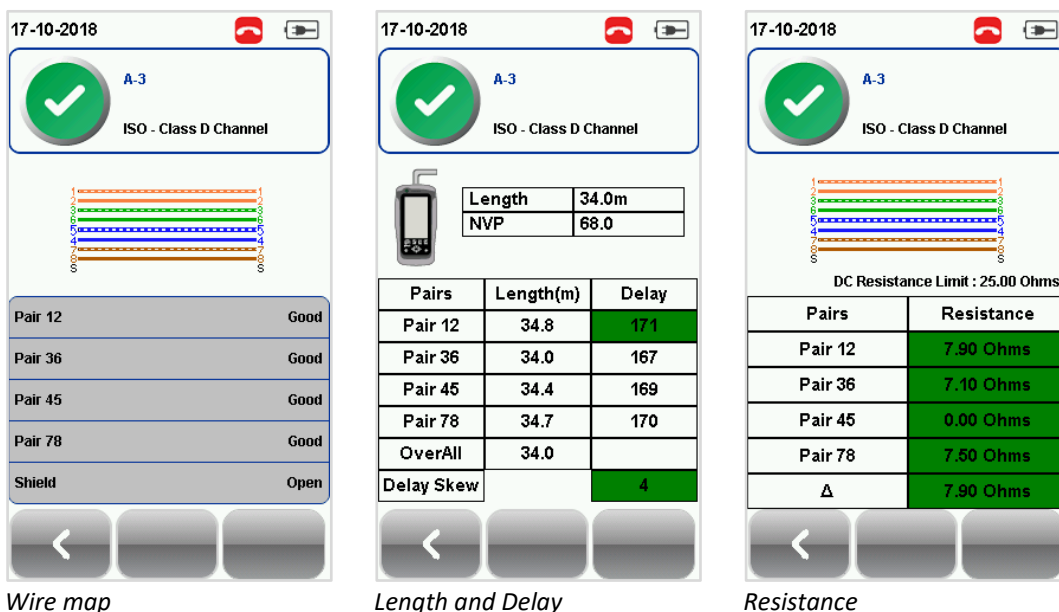

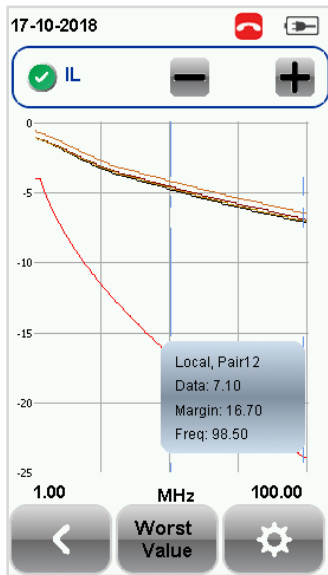

Insertion Loss

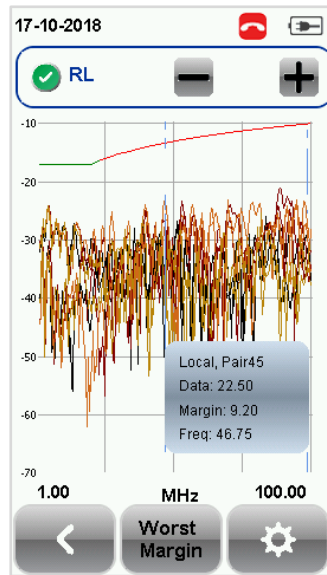

Return Loss

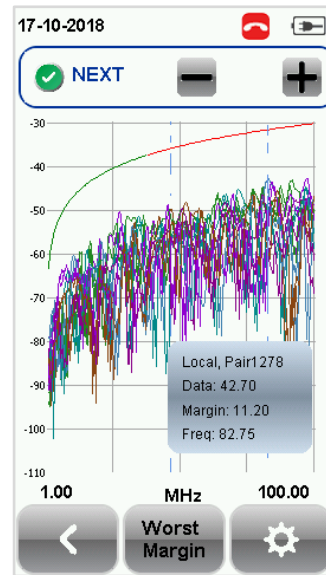

Near-end Crosstalk

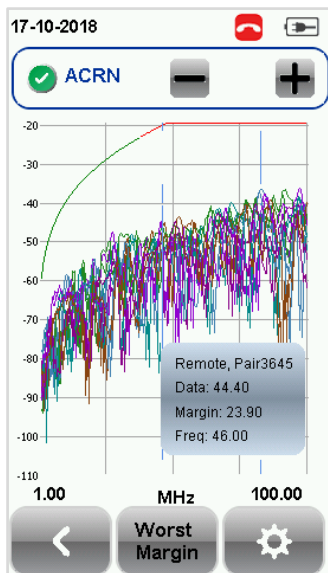

Attenuation to Crosstalk Ratio, Near-end (ISO only)

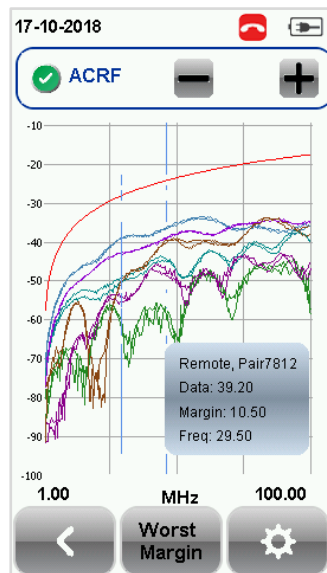

Attenuation to Crosstalk Ratio, Far-end

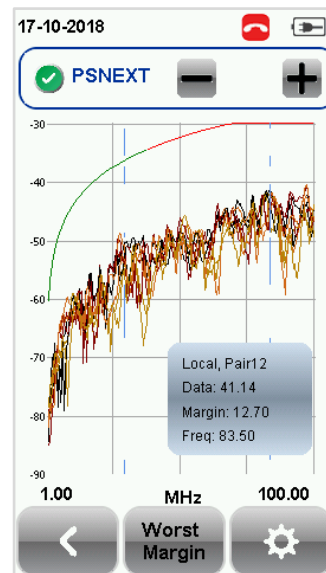

Power-sum NEXT

Fehler! Verwenden Sie die Registerkarte 'Start', um Heading 1 dem Text zuzuweisen, der hier angezeigt werden soll.

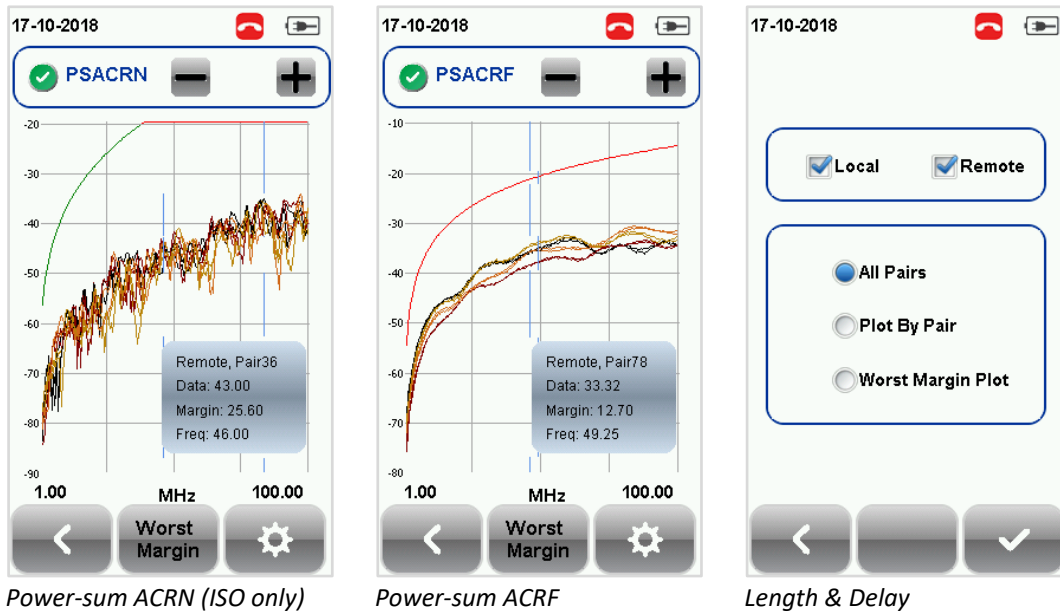

7.2 NEXT and RL Fault Locating

If the Locator option is enabled in the **Test Settings** → **Test Options**, WireXpert will display extremely critical troubleshooting information in the form of a Time Domain Reflection plot for NEXT and Return Loss.

Near-End Crosstalk (NEXT) is an undesired effect of interference between two pairs in a cable measured at the same end of the cable as the interfering transmitter. In crosstalk, the signals traveling through adjacent pairs of wire in twisted-pair cabling interfere with each other. Cross talk is undesirable.

The NEXT Locator displays the locations where crosstalk is excessive in the cable and indicates the exact location in meters or feet from the LOCAL unit of where high crosstalk issue is seen. View individual plot by selecting/deselecting cable pairs. Each two pairs of cables that have been tested for crosstalk are represented by different color in the plot.

Return Loss (RL) is the measurement (in dB) of the amount of signal that is reflected back toward the transmitter. Impedance mismatches and discontinuities caused by terminations to plugs or jacks and within the plug/jack connection itself contributes to RL. Excessive bends and damaged cable will also contribute to RL. The greater the variation in impedance, the greater the return loss reading.

The RL Locator displays the locations where return loss occurred during an AUTOTEST and indicates the exact location of where the highest return loss occurs. View individual plot by selecting/deselecting cable pair. Each pair of cables that has been tested is represented by different color in the plot.

Each peak result in NEXT and RL Locator could represent a new joint connection, rarely a coupler and not necessary a bad cable that requires replacement.

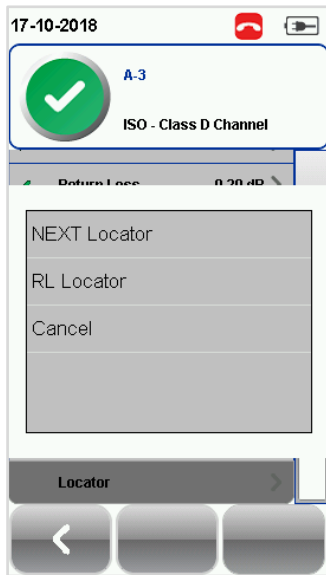

Locator – To enable, press the [SETUP] button → Test Settings → Test Options → Locator

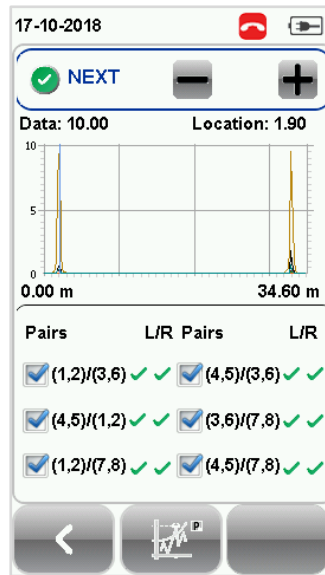

NEXT Locator

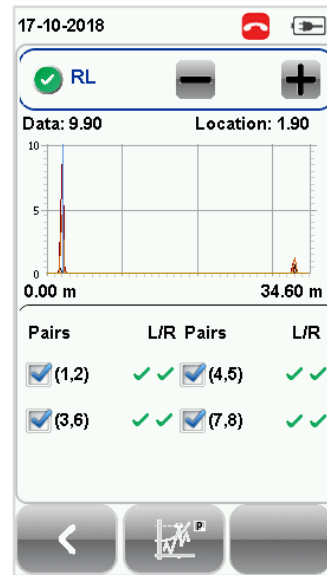

Return Loss Locator

7.3 Managing test result(s)

Test results can be manually saved by pressing the [Save] button after an AUTOTEST is completed. When prompted, enter label name and click [OK] to save.

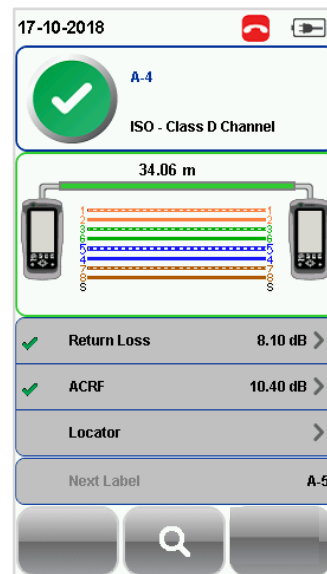
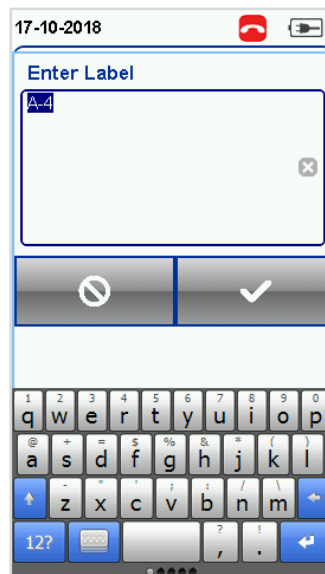
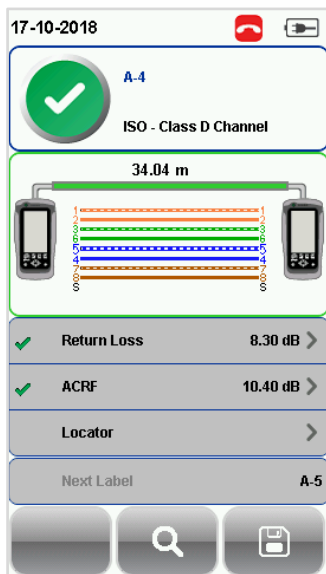

The [Save] icon will disappear once saving is completed.

Test results will be named in alpha-numeric sequence with reference to the selected Label Source ([SETUP] → Project Settings → Label Source) when AUTOTEST is completed.

PASS results will automatically be saved if the “Auto Save” option is enabled. FAILED results will be saved manually.

Fehler! Verwenden Sie die Registerkarte 'Start', um Heading 1 dem Text zuzuweisen, der hier angezeigt werden soll.

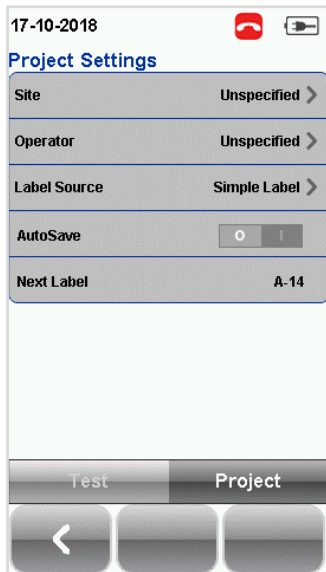

To view saved results,

1. Press the **[DATA]** button.
2. Select **[Copper]** and press the **[View]** button.
3. Select the test results click **[View]** to view results.
4. Select the next page for more results.

To delete a saved result,

1. Press the **[DATA]** button.
2. Select **[Copper]** and press the **[View]** button.
3. Press the **[Manage]** button.
4. Select result(s) and press the **[Delete]** to delete result(s).

To rename a saved result,

1. Press the **[DATA]** button.
2. Select **[Copper]** and press the **[View]** button.
3. Press the **[Manage]** button.
4. Select result and press the **[Rename]** to rename result.

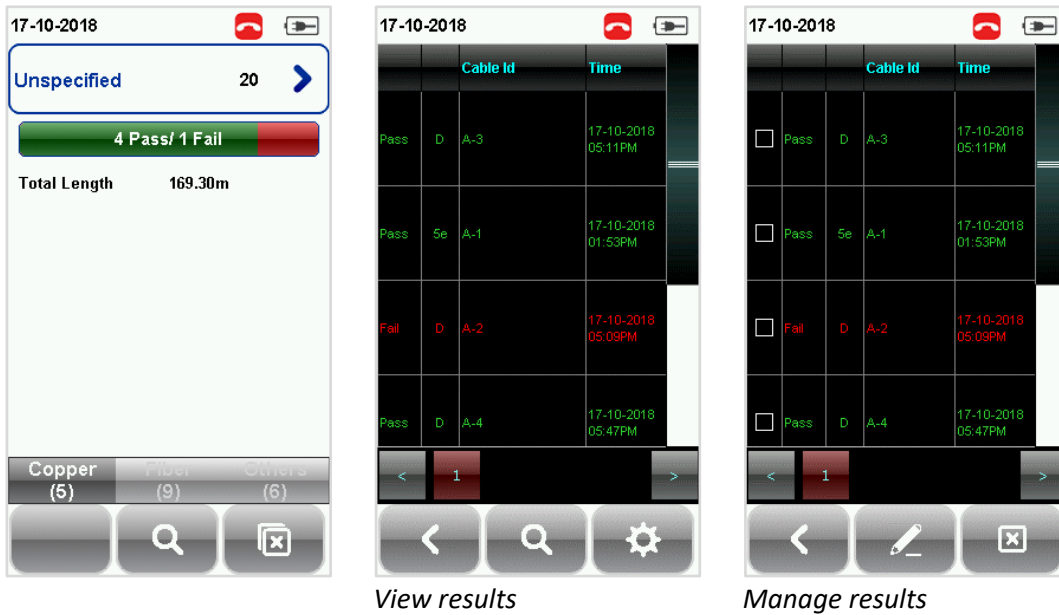

7.4 Exporting test results into eXport PC Software

eXport is a data management software designed to work seamlessly with WireXpert. Saved results can be exported using the following methods;

7.4.1 USB Flash Drive

1. Insert USB flash drive to USB port on WireXpert.
2. Device will automatically detect flash drive.
3. Otherwise, press the [SETUP] button → **System Settings** → **Settings 2** → **Storage** → **USB**
4. Select [Test Results].
5. Click [OK] to proceed.

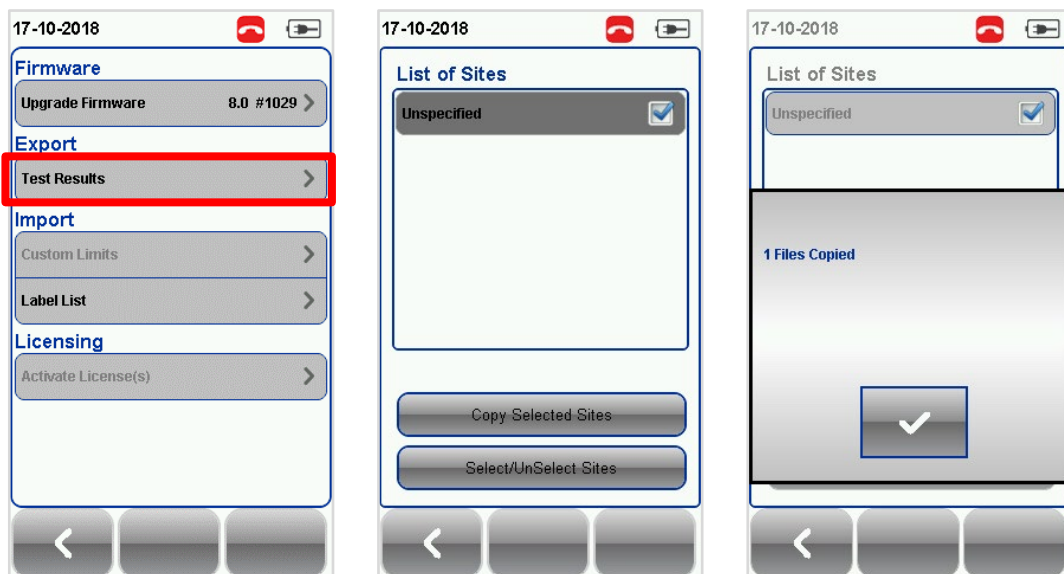

6. Launch eXport software.

Fehler! Verwenden Sie die Registerkarte 'Start', um Heading 1 dem Text zuzuweisen, der hier angezeigt werden soll.

7. Go to **File** → **Create New Project** to create new project space.

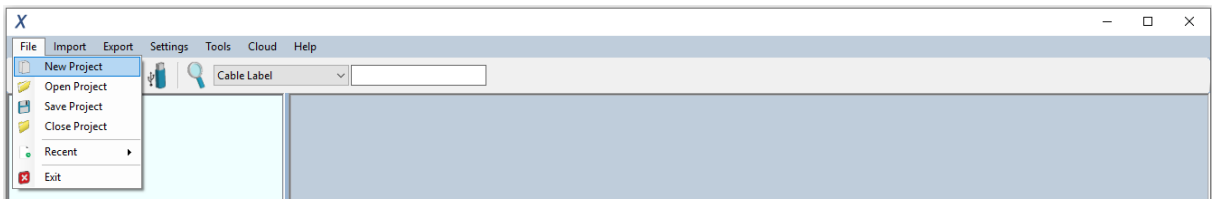

8. Go to **Import** → **USB Flash Drive** and select the flash drive. Click **[Import]**.

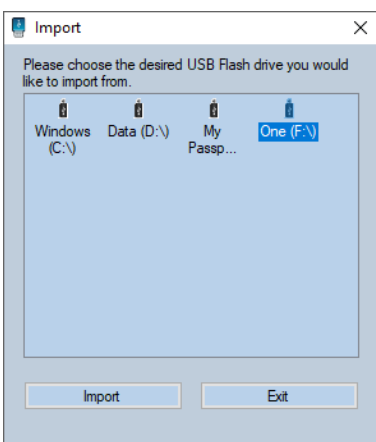
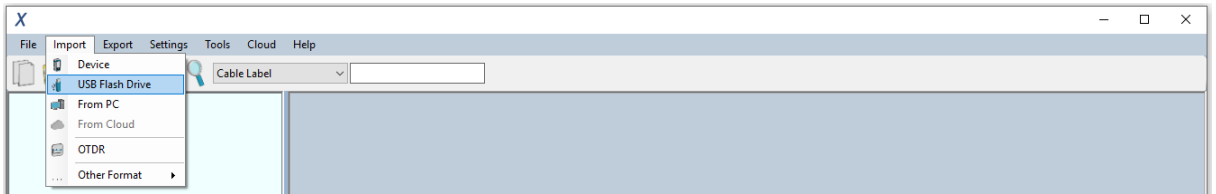

9. Select database and click **[Import Selected]** to import or click **[Import All]** for all databases.

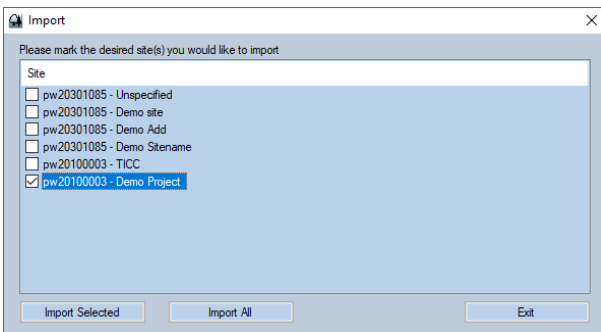

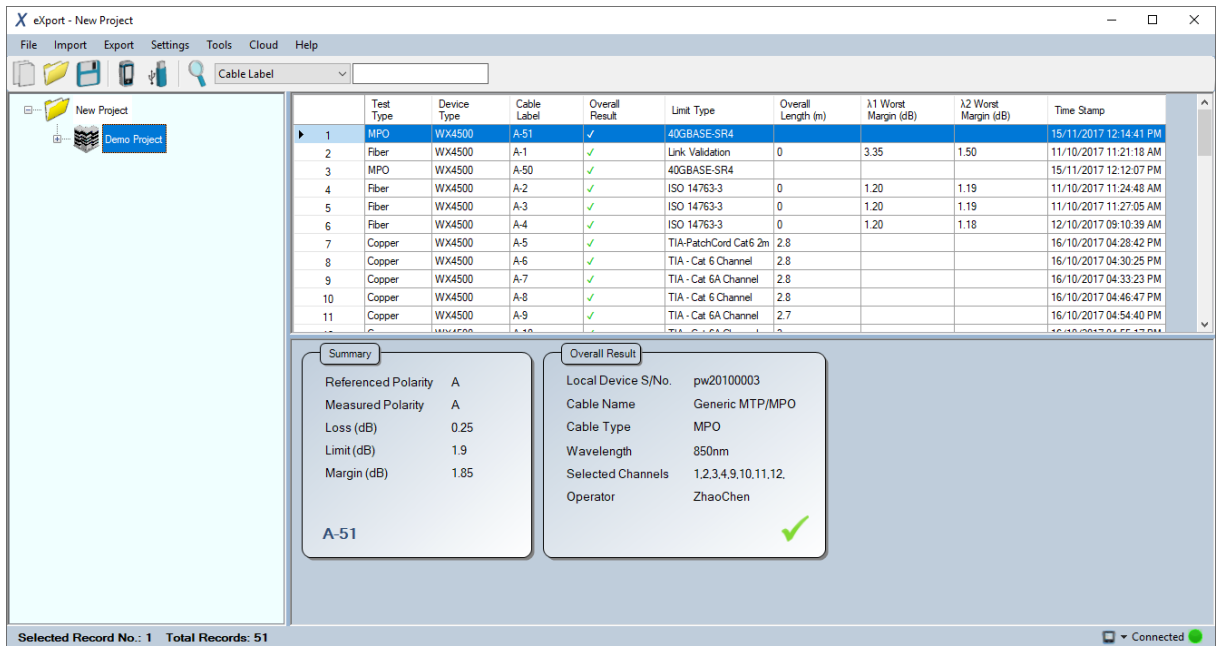

7.4.2 Direct connection via USB cable

1. Connect WireXpert to your PC using a mini USB cable.
2. Launch eXport software.
3. Go to **File** → **Create New Project** to create new project space.
4. Go to **Import** → **Device**.

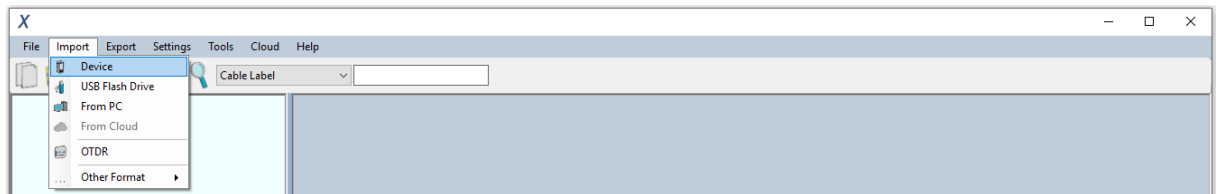

5. Select database and click **[Import Selected]** to import or click **[Import All]** for all databases.

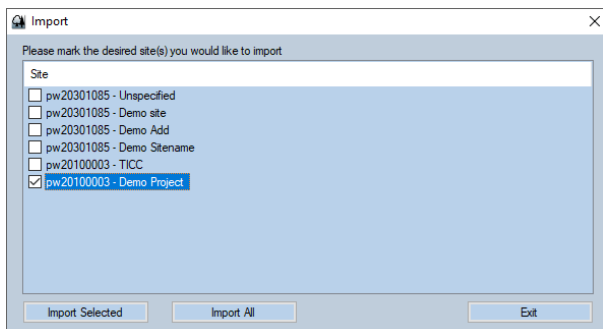

User Manuals

Refer "User Manual – eXport" for more information on how to use the software.

8 Declarations

EU Declaration of Conformity



We

Softing Singapore Pte. Ltd.
3 Science Park Drive
#03-09, The Franklin
Singapore Science Park 1
Singapore 118223

declare under our sole responsibility that the products

Model / Description

WX4500-FA	/	WireXpert cable certifier 2500 MHz
WX500-CU	/	WireXpert cable certifier 500 MHz
WX_AD_VCL_MM1/MM2	/	Multi mode fibre adapter
WX_AD_EF_MM1/MM2	/	Multi mode fibre adapter (encircled flux compliant)
WX_AD_SM1/SM2	/	Single mode fibre adapter
WX_AD_MM_MPO_KIT/ SOURCE/PWRMETER	/	Multi mode MPO adapters

including associated accessories and cables supplied by Softing Singapore, comply with the requirements of the following directives:

EMC directive 2014/30/EU

Low Voltage Directive 2014/35/EU

RoHS directive 2011/65/EU

REACH Regulation (EC) 1907/2006 including tracking changes to the SVHC list published by ECHA on an ongoing basis. As of 21st February 2017, 173 SVHCs are listed.

Applied harmonised standards:

EN 55024 (2003-10) : Information technology equipment – Immunity characteristics – Limits and methods of measurement

EN 55022 (2008-05) : Information technology equipment – Radio disturbance characteristics – Limits and methods of measurement

IEC 60950-1:2005 (Second Edition) + Am 1:2009 + Am 2:2013 : Information technology equipment – Safety – Part 1 : General requirements

Simon Harrison
General Manager

21st February 2017

Date

Template version 2.1		Document No: 3000-0007
----------------------	--	------------------------

This device complies with the requirements of the EC directive 2004/108/EG "Electromagnetic Compatibility" (EMC directive). It meets the following requirements:



Note

A Declaration of Conformity in compliance with the above standards has been made and can be requested from Softing Singapore Pte Ltd.



China ROHS

The WireXpert device and its test components are China ROHS compliant.



WEEE

Electrical and electronic equipment must be disposed of separately from normal waste at the end of its operational lifetime.



Please dispose of this product according to the respective national regulations or contractual agreements. If there are any further questions concerning the disposal of this product, contact Softing IT Networks.



CAUTION

This is a Class A product. In a domestic environment this product may cause radio interference. In that case the user may be required to take adequate measures!



ROHS

The WireXpert device and its test components are ROHS compliant.



Intertek

ETL Intertek Verified

WireXpert device is ETL verified to ANSI/TIA IIIe, IEC 61935-1 levels IIIe & IV and currently proposed Level V draft, with the applicable measurement accuracy.



Class 1 Laser Product

The light source transmitted from the following fiber test modules – Single Mode (SM), Multi-Mode (MM) and Encircled Flux compliant Multi-Mode (MMEF) are classified as Class 1 lasers and are very low risk and "safe under reasonably foreseeable use", including the use of optical instruments for intrabeam viewing.















Declarations









Class 1m Laser Product

The light source transmitted from the following fiber test modules – MPO REMOTE are classified as Class 1m lasers and have wavelengths between 302.5 nm and 4000 nm and are safe except when used with optical aids.

1 9 Appendix

 <p>[Add]– Adds a site, operator or customised cable, connector to the database.</p>	 <p>[Retest] – Performs an AUTOTEST on selected result on List-Based Testing.</p>	 <p>[Back] – Returns to previous screen. Unsaved options will be discarded.</p>
 <p>[Cancel] – Discards option.</p>	 <p>[Delete] – Deletes a site, operator or customised cable, connector from the database.</p>	 <p>[View]– View selected result.</p>
 <p>[Manage] – Enables [Rename] and [Select all] options.</p>	 <p>Format, Reset – Performs non-reversible setting/data restoration to factory defaults.</p>	 <p>Forward – Proceed to the next screen.</p>
 <p>[Device info] – Displays device firmware build information.</p>	 <p>[OK] – Confirms and saves current option.</p>	 <p>[Rename] – Renames saved test result in the DATA menu.</p>
 <p>[Restart] – Restarts current procedure.</p>	 <p>[Save] – Saves current test result. Icon will disappear after a successful save.</p>	 <p>[USB] – Reads USB flash drive to perform upgrade firmware, test result export or custom limit and label list import</p>

 <p>[Select all] – Selects all data on screen.</p>	 <p>[Next pair] – View next pair of plots of the current result.</p>	 <p>Fibermap – Displays mapping of fiber being tested.</p>
 <p>[MPO chart/grid] – Toggles between displaying of power loss in bar chart or grid format for fiber testing.</p>	 <p>[Scope live/test] – Toggles between 'Live' and 'Test' mode when inspecting a SM/MM fiber with the inspection scope.</p>	 <p>[Set Reference] – Performs result referencing between the LOCAL and REMOTE units.</p>
 <p>[Transmit ON/OFF] – Toggles between enabling and disabling of light source on the REMOTE unit.</p>		

10 Glossary

AC Wire Map: Feature in WireXpert that enables test runs measurements with Power over Ethernet (PoE) midspan devices in between. WireXpert supports cable runs with IEEE 802.3 af and 802.3 at injectors. Recommended to disable when not performing a test through a PoE device.

ACRF: Acronym for Attenuation to Crosstalk Ratio Far-end, formally known as Equal Level Far End Crosstalk (ELFEXT), is a calculated parameter, derived from subtracting the attenuation of the disturber at the far end pair from the FEXT on the disturbed pair. This is expressed in dB.

ACRN: Acronym for Attenuation to Crosstalk Ratio Near-end, formally known as ACR, is a calculated parameter, derived from subtracting the attenuation of the disturber pair from the NEXT on the disturbed pair. This is expressed in dB. Test parameter is not required for TIA cabling standards.

Adapter: The modular test probe used with WireXpert when used in this Manual's context, unless otherwise stated.

CAT: Abbreviation for "Category", describes the transmission performance and construction of copper cabling links associated with ANSI/TIA-568 Standards.

Channel: Definition of cabling elements in horizontal cabling, permanently installed data cable including patch cords/jumpers at each end.

Class: Describes the transmission performance and construction of copper cabling links associated with ISO/IEC 11801 Standards.

Crosstalk: Disturbance caused by the electric or magnetic fields along a cable pair. It can occur when removing too much of the pair shield or untwisting pairs too much during termination,

using the wrong components, selecting wrong settings or using inferior quality test setups.

Crossover Cable: Cable used to connect two devices of the same type, e.g., two computers or two switches. Example, a crossover cable can have the following A-to-B ends pin-outs: 1-3, 2-6, 3-1, 4-7, 5-8, 6-2, 7-4, 8-5.

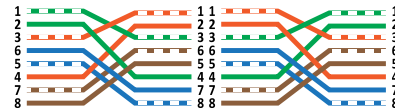

Crossed Pairs: Generally referring to wiring fault, also known as Transposed Pairs, is a twisted pair connected to completely different pin pairs at both ends.

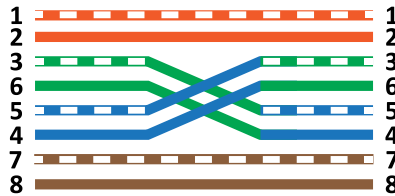

Crossover cable is an example of crossed pair cable, but not crossed pair cables are crossover cables.

dB: Acronym for decibel, is the ratio unit used to measure the power level of an electrical signal by comparing it with a given level on a logarithmic scale.

DCRU: Acronym for Direct Current Resistance Unbalance, is the measurement of DC resistance between and in pairs of twisted pair LAN cabling.

DCS: Acronym for Dual Control System, is a unique feature of WireXpert that provides real-time graphical test data on both the LOCAL and REMOTE units.

Delay Skew: Refers to test used to determine the difference in propagation delay between the fastest and slowest set of wire pairs. In general, the lower the skew value, the better.

Device: Refers to WireXpert unit in this Manual's context, unless otherwise stated.

E2E: Acronym for End-to-End. Generally referring to End-to-End links.

Application that requires direct connection to machines or machines to network devices in the industrial environment, potentially containing 1 or multiple segments with 2 or multiple connections in the link.

EULA: Acronym for End User License Agreement. Starting from v7.3, user will require to read and agree to the terms and conditions stipulated by Softing before proceeding to use WireXpert and eXport PC firmware.

eXport: Project management PC software to seamlessly work with WireXpert. Required to upgrade device firmware. Not to be confused with actions "file export".

FTP: Acronym for Foil-screened Twisted Pairs. See F/UTP. Not to be confused with "File Transfer Protocol".

F/FTP: Cable with overall foil shield with FTP. Commonly used in 10GBaseT applications.



F/UTP: Cable with an overall foil shield (F) with UTP. Commonly used in 10GBaseT applications. Also known as FTP.



GUI: Acronym for Graphical User Interface, generally referring to the touchscreen interface on WireXpert in this Manual's context, unless otherwise stated.

IL: Acronym for Insertion Loss, is the loss of signal power resulting from the insertion of jack to a plug. This is expressed in dB.

In-Pair: Generally referring to effects within a pair of wires (eg., pins 1 & 2) in twisted pairs cable in this Manual's context.

ISO: Acronym for International Organization of Standardization. Generally referring to ISO/IEC 11801 Standards for generic cabling for general purpose telecommunication cabling systems or structured cabling.

Jack: Generally referring to a connector with female electrical contact or socket.

LBT: Acronym for List-Based Testing, is a unique feature of WireXpert that allows creation of label list and perform AUTOTEST in a hierarchical format.

Limit: Or test limit, refers to the performance threshold that a cable installation is obliged to meet.

Link: See Permanent Link.

LOCAL: Refers to the WireXpert unit labelled "LOCAL".

Margin: Refers to the difference between the selected test limit value and the measured value. This is expressed in dB. In general, a higher positive margin value represents a good test result, a negative value represents a FAIL test, and zero when the measured value is the same as the test limit.

Marginal: Generally referring to marginal PASS/FAIL, refers to the tested value's margin is smaller than the accuracy for the test parameter.

NEXT: Acronym for Near-End Crosstalk, is the measurement of the ability of a cable to reject crosstalk. In general, the higher the NEXT value, the greater the rejection of crosstalk at the local connection.

NVP: Acronym for Nominal Velocity of Propagation, is the speed at which the data signals travel down the cable expressed as a percentage of the speed of light in a vacuum. NVP is required to determine the length of a cable during a test.

P2P: Acronym for Pair-to-Pair, generally referring to effects between two pairs

of wires (eg., 1,2 & 3,6) in twisted pairs cable in this Manual's context.

Patch Cord: Also known Patch Cable, is an electrical cable used to connect one electronic to another for signal routing. Commonly produced in different colors, and are usually not longer than 2 metres.

Patch Panel: Also known as Patch Bay, is a device or unit featuring a number of jacks, for connecting and managing incoming and outgoing LAN cables.

Plug: Generally referring to a connector with male electrical contact or pin.

Permanent Link: Definition of cabling elements in horizontal cabling, permanently installed data cable.

PoE: Acronym for Power over Ethernet, is the technology for wired Ethernet LANs that allows electrical current required for operation of devices to be carried by data cables.

Probe: Generally referring to a device used to connect a test equipment to a device under test, e.g., the Channel adapter and Video Inspection Scope are probes to the WireXpert.

Propagation Delay: The measurement of how long it takes for the signal to travel down the cable being tested.

PSACRF: Acronym for Power Sum ACRF, formally known as Power Sum Equal Level Far-End Crosstalk (PSELFEXT), is the difference between the test signal and the crosstalk from the other pairs received at the far end of the link. This is expressed in dB.

PSACRN: Acronym for Power Sum ACRN, formally known as Power Sum Attenuation to Crosstalk Ratio (PSACR), is the difference between each wire pair's attenuation (IL) and the combined crosstalk received from the other pairs. In general, higher PSACRN values corresponds to better cabling performance. This is expressed in dB. Test parameter is not required for TIA cabling standards.

PSNEXT: Acronym for Power Sum NEXT, is the sum of NEXT values from three wire pairs as the affect the other wire pair. There will be four PSNEXT results at each end of the link tested. In general, the higher the PSNEXT value, the lower the crosstalk.

REMOTE: Refers to the WireXpert unit labelled "REMOTE".

Reference Cord: Generally referring to the patch cord used for setting reference prior to performing an AUTOTEST.

Reversed Pairs: Generally referring to wiring fault, a twisted pair is not connected with straight-through pin-to-pin continuity. (eg., Pins 1 & 2 are reversed.)

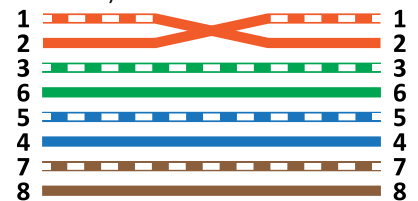

RL: Acronym for Return Loss, is a measurement of reflections caused by the impedance changes at all locations along the link. This is expressed in dB.

Set Reference: The compensation for the effects of ambient conditions, e.g., ambient temperature, in the LOCAL and REMOTE units, to ensure maximum measurement accuracy of WireXpert.

Shielded: Generally referring to an electrical cable or connector being enclosed in or by conductive layers to provide noise screening.

Shield Test: Also known as Shield Integrity Test, refers to the identification of a shield being present and connected at both ends on the actual cable under test.

Single Ended Test: Feature in WireXpert, referring to the ability to determine the loss of copper cable at one end without the use of the REMOTE unit.

Split Pairs: Generally referring to wiring fault, individual wires from two

different twisted pairs are connected to a set of pins that are supposed to be connected to a real pair of wires. The fault usually happens when the same wires are swapped on both sides of the link. (eg., Pins 3 & 5 are swapped on both sides of the link.)

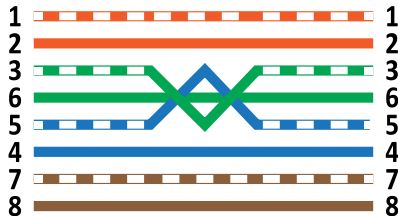

S/UTP: Cable with an overall braid screen (S) with unscreened UTP. Also known as STP.

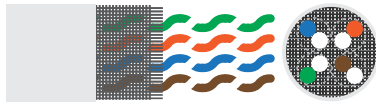

STP: See S/UTP.

S/FTP: Cable with an overall braid screen (S) with FTP. The “shield” underneath the jacket is a braid, and each individual pair is surrounded by its own foil barrier. The additional foil on the individual pairs limit the amount of crosstalk between them. Also known as S-STP.



SF/UTP: Cable with both an overall braid screen (S) and foil shield (S) with UTP. The overall braided screen is very effective at protecting EMI from entering or exiting the cable. Also known as S-FTP.



Straight Through Cable: Cable used to connect computers to hubs or switches. A straight through cable has the following A-to-B ends pin-outs: 1-1, 2-2,

3-3, 4-4, 5-5, 6-6, 7-7, 8-8.

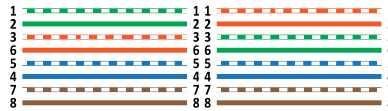

T568A/B: T568A and T568B are two color codes approved by ANSI/TIA/EIA that are used for wiring eight-position RJ45 plugs.

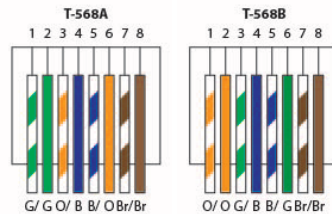

TIA: Acronym for Telecommunications Industry Association. Generally referring to TIA-568 Standards for telecommunication products and services.

TIA-606-A: The guidelines and choices of classes of administration for maintaining telecommunications infrastructure as defined by the TIA Standards.

Unshielded: Generally referring to an electrical cable or connector that are not enclosed in or by conductive layers.

U/FTP: Cable without overall shielding or braid (U) with FTP. Commonly used in 10GBaseT applications.



UTP: Acronym for Unscreened Twisted Pairs. See U/UTP.

U/UTP: Cable without shielded with UTP. Also known as UTP.



Wiremap: The parameter that checks the correct termination of cable wires in telecommunication outlets and patch

11 Related documents

Application Note – E2E Link Test

Application Note – MPTL

Quick Start Guide – Copper Certification Testing

Quick Start Guide – Fiber Certification Testing

Quick Start Guide – Encircled Flux Compliant Multimode Fiber Certification Testing

Quick Start Guide – MPO Certification Testing

Quick Start Guide – Digital Fiber Inspection Kit

User Manual – Fiber Certification Testing

User Manual – MPO Certification

User Manual – eXport

User Manual – CAT6A+ Adapters

User Guide – List Based Testing

User Guide – Installing eXport PC Software

User Guide – License Upgrade

User Guide – eXport Cloud

User Guide – Custom Limits

User Guide – Tone Generator

12 Technical Support

Softing's global presence ensures our customers receives sales and technical support anywhere around the world. For more information: <https://itnetworks.softing.com>

The Americas

Softing Inc.

7209 Chapman Highway
Knoxville, TN 37920
Phone: +1 865 251 5252
E-mail: sales@softing.us

Asia / Pacific

Softing Singapore Pte. Ltd.

73 Science Park Drive
#02-12/13, Cintech I
Singapore Science Park 1
Singapore 118254
Phone: +65-6569-6019
E-mail: asia-sales.itnetwork@softing.com

Softing Shanghai

Room 416, 4/F, Mytech Intelligence Park,
No.1999 East Jinxiu Road, Pudong District,
201206, Shanghai, China
Phone: +86 (21) 61063031
E-mail: china-sales.itnetwork@softing.com

Europe/Middle East/Africa

Softing IT Networks GmbH

Richard-Reitzner-Alle 6
D-85540 Haar, Munich
Phone: +49 89 45 656 660
E-mail: info.itnetworks@softing.com

Softing SRL

87 Rue du Général Leclerc
Creteil, Île-de-France
94000 (Paris)
Phone: +33 1451 72805
E-mail: info.france@softing.com

Softing Italia Srl.

Via M. Kolbe, 6
20090 Cesano Boscone (MI)
Phone: +39 02 4505171
E-mail: info@softingitalia.it

Austria

Buxbaum Automation GmbH
Eisenstadt
Phone: +43 2682 7045 60
E-Mail: office@myautomation.at