

optimize!
softing

WireXpert 4500

ENGLISH



Fiber USER MANUAL

IT Networks



itnetworks.softing.com

Disclaimer of liability

The information contained in these instructions corresponds to the technical status at the time of printing of it and is passed on with the best of our knowledge. The information in these instructions is in no event a basis for warranty claims or contractual agreements concerning the described products and may especially not be deemed as warranty concerning the quality and durability. We reserve the right to make any alterations or improvements to these instructions without prior notice. The actual design of products may deviate from the information contained in the instructions if technical alterations and product improvements so require.

It may not, in part or in its entirety, be reproduced, copied, or transferred into electronic media.

Softing Singapore Pte Ltd

73 Science Park Drive
#02-12/13 Cintech I
Singapore Science Park 1

itnetworks.softing.com



+ 65 6569 6019



+ 65 6899 1016



asia-support.itnetworks@softing.com

The latest version of this manual is available in the Softing download area at: itnetworks.softing.com/downloads

Version: WireXpert4500_Fiber_IT_EN_U_201811

© 2019 Softing Singapore Pte Ltd. In line with our policy of continuous improvement and feature enhancement, product specifications are subject to change without notice. Subject to errors and alterations. All rights reserved. Softing and the Softing logo are trademarks of Softing AG. WireXpert and the WireXpert logo are trademarks of Softing IT Networks GmbH. All other cited trademarks, product and company names or logos are the sole property of their respective owners.

Table of Contents

1	Introduction	4
1.1	About product	4
1.2	Safety precautions	4
1.3	Intended use	5
1.4	About this document	5
1.5	Before you start	6
1.6	Scope of delivery	7
1.7	System requirements	8
2	WireXpert PC Software and Firmware.....	9
2.1	Install software.....	9
2.2	Upgrade firmware	9
3	WireXpert User Interface	11
3.1	Touch Screen Layout	11
3.2	The One Touch Access Button.....	12
4	Setting Reference	21
4.1	One jumper Dual-ended.....	21
4.2	Two jumpers Dual-ended.....	24
4.3	Three jumpers Dual-ended	26
4.4	One jumper Single-ended Loopback	28
4.5	Two jumpers Single-ended Loopback	30
4.6	Three jumpers Single-ended Loopback	32
5	Configuring an AUTOTEST	36
5.1	Setting up WireXpert.....	36
5.2	Testing Guide for Dual-ended Testing.....	37
5.3	Testing Guide for Dual-ended Testing.....	38
6	Performing an AUTOTEST	39
6.1	Understanding AUTOTEST.....	39
6.2	Managing test result(s)	41
6.3	Exporting test results into eXport PC Software.....	42
7	Declarations	43
8	Appendix	46
9	Glossary.....	48
10	Related documents.....	50
11	Technical Support	51

1 Introduction

1.1 About product

Softing's WireXpert, with its unparalleled 2,500 MHz measurement range, is the first cable certifier with capability to certify the highest performance cabling systems in enterprise networks and data centers. Cable installers make significant gain in productivity with WireXpert's industry leading test speed and ease of use. With certification testing up to Class F_A and CAT8 copper cabling, as well as MPO, SM, MM and MMEF fiber optic cabling, WireXpert is ready for 40G and beyond.

Starting from v7.4, WireXpert is available in four variants to provide more flexibility to suit your certification requirements:

- WireXpert 500 copper (up to 500MHz) only
- WireXpert 500 fiber only
- WireXpert 500-plus; copper + fiber
- and WireXpert 4500.

The WireXpert 500 series provides an affordable solution that can grow with your cable certification needs. Upgrade the copper only or fiber only variants to the combined WireXpert 500-plus or WireXpert 4500 for the full 2,500MHz capability.

1.2 Safety precautions



Read this manual before starting

For damages due to improper connection, implementation or operation Softing refuses any liability according to our existing warranty obligations.



Note

This symbol is used to call attention to notable information that should be followed during installation, use, or servicing of this device.



Hint

This symbol is used when providing you with helpful user hints.



CAUTION

Selection of option may cause all or partial of saved data and/or settings in the device to be erased or restored to non-reversible original factory state. Backing up of saved result(s) is recommended before executing option.

CAUTION

CAUTION indicates a potentially hazardous situation which, if not avoided, may result in minor or moderate injury.



WARNING indicates a potentially hazardous situation which, if not avoided, could result in death or serious injury.



DANGER indicates an imminently hazardous situation which, if not avoided, will result in death or serious injury. This signal word is to be limited to the most extreme situations.

1.3 Intended use

WireXpert series has been designed for use in factory, process and building control. The unit must not be used in explosion hazard areas. The permissible ambient conditions given in the Technical Data must be complied with.

The faultless and safe operation of the product requires proper transport, proper storage and installation, and expert operation and maintenance in accordance with the manual.

1.4 About this document



Read this manual before starting

For damages due to improper connection, implementation or operation Softing refuses any liability according to our existing warranty obligations.

1.4.1 Document history

Document version	Modifications compared to previous version
201702	Firmware update to v7.3
201811	Firmware update to v8.0

1.4.2 Conventions used

The following conventions are used throughout Softing customer documentation:

Keys, buttons, menu items, commands and other elements involving user interaction are set in bold font and menu sequences are separated by an arrow	Open Start → Control Panel → Programs
Buttons from the user interface are enclosed in brackets and set to bold typeface	Press [Start] to start the application
Coding samples, file extracts and screen output are set in Courier font type	MaxDlsapAddressSupported=23
Filenames and directories are written in italic	Device description files are located in <i>C:\<productname>\delivery\software\Device Description files</i>

1.5 Before you start

Check that the latest eXport PC software and firmware is installed in the workstation and WireXpert respectively to ensure the latest features are available.

Key differences between WX4500 and WX500 series

Features	WX4500-FA	WX500-PLUS	WX500-CU	WX500-FIBER
Frequency of measurement	2500 MHz	500 MHz	500 MHz	N/A
Accuracy Specification	TIA Level 2G ISO/IEC Level VI	TIA Level IIIe ISO/IEV Level IIIe	TIA Level IIIe ISO/IEC Level IIIe	N/A
Fiber Testing option	Yes	Yes	No	Yes
Class F _A /CAT 8 options	Yes	No	No	No
Patch Cord Test adapters	Yes	Yes	Yes	No

Softing recommends WireXpert to be calibrated annually. Starting from v7.4, WireXpert will remind the user to calibrate the units or fiber adapters if the last calibration was more than one year ago. This notification can be closed by clicking the **[OK]** button, but will be displayed on every boot up until the units are calibrated.

Calibration can only be done by the service center. Please contact your local vendor for more information.

1.6 Scope of delivery

WireXpert 500 – Fiber only solution



WireXpert 500
Single Mode (SM) adapters only
Cord kits excluded
(WX500-SM)



WireXpert 500
EF Multi Mode (MMEF)
adapters only
Cord kits excluded
(WX500-MMEF)



WireXpert 500
SM and MMEF adapters only
Cord kits excluded
(WX500-QUAD)

Single Mode Fiber (WX_AD_SM2)



Single Mode Adapters
(WX_AD_SM2)

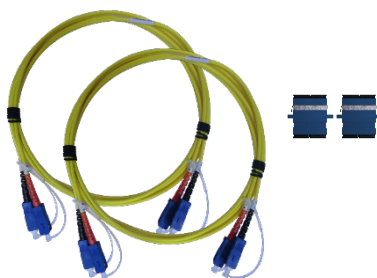

SC-SC Duplex Reference Cords
(WX_AC_SM_REFCORD_SC)
Mating Couplers



SC Cleaning Kit
(WX_AC_SC_CLEANING_KIT)

Encircled Flux Compliant Multi Mode Fiber (WX_AD_EF_MM2)



Multi-Mode Adapters
(WX_AD_EF_MM2)

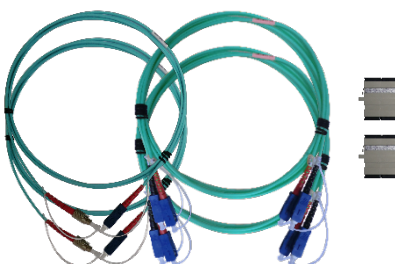

FC-SC Modally Transparent
Reference Cords
SC-SC Tail Cords
(WX_AC_EF_MM_REFCORD_SC)
2)
Mating Couplers



SC Cleaning Kit
(WX_AC_SC_CLEANING_KIT)

Optional SM/MM/MMEF LC Cord Kits available.

	Single Mode	Encircled Flux MM
Wavelengths	1310nm, 1550nm	850nm, 1300nm
Connector Type (Cable)	1. SC 2. LC (Optional)	1. SC-SC + FC-SC 2. LC-SC + FC-SC (Optional)
Test Standards	TIA 568 C.3 IEC 14763-3	TIA 568 C.3 IEC 14763-3 IEC 61280-4-1
Test Parameters		
Loss	0 to 24 dB, ± 0.2 dB	0 to 12 dB, ± 0.2 dB
Length	0 to 20,000m, ± 1.5 m plus $\pm 1.5\%$ of length	0 to 2,000m, ± 1.5 m plus $\pm 1.5\%$ of length
Output Power	≥ -9 dBm	≥ -22 dBm
Receiver Sensitivity	-40 dBm	-40 dBm
VFL Wavelength	NA	650 μ m

1.7 System requirements

Hardware

- PC

Operating system

- Windows 7, 8 or 10 (32 bit or 64 bit)
- Intel Core i3 Duo, 2.4GHz
- 1 GB of RAM
- 200 MB of free space of installation
- Microsoft .NET framework

2 WireXpert PC Software and Firmware

2.1 Install software

- 1 Download the latest eXport PC software from itnetworks.softing.com
- 2 Run eXport setup v8.0.x64.exe
- 3 Follow through the instructions on the screen and click [Next] to proceed.
- 4 Click **[Install]** to begin installation.
- 5 Click **[Finish]** to complete installation.
- 6 If this is an upgrade from an earlier version from 6.x and above, click **[Yes]** to proceed.

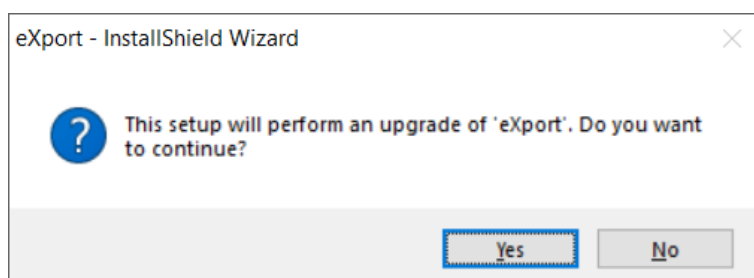

- 7 Follow the instructions to complete installation.



User Manuals

For more information on installation and using eXport PC software, please refer to “Installation Guide for eXport PC software” and “User Manual for eXport PC software”.



Note

Softing IT Networks has ceased support for ReportXpert v5.x and earlier. Please contact asia-support.itnetworks@softing.com for more information.

2.2 Upgrade firmware

- 1 Download and install the latest eXport PC software.
- 2 Connect an USB flash drive to the workstation.
- 3 Run eXport PC software.
- 4 Go to **Tools → Update Device Firmware**.
- 5 Click **[OK]** and select USB drive from “Export to USB” window.
- 6 Click **[Export]** and **[OK]** to proceed.
- 7 Please wait while exporting takes place. This process may take a while.
- 8 Remove USB flash drive from workstation and connect to WireXpert.
- 9 Select **[Upgrade Firmware]** from prompt and click **[OK]** button to continue.
Note: Both LOCAL and REMOTE units must be upgraded.

- 10 If prompt did not appear, check that USB icon is present on the status bar, and press the **[SETUP]** button → **System Settings** → **Settings 2** → **Storage** → **USB**.
- 11 Please wait while upgrading takes place. This process may take a while.
- 12 Upgrade process is complete.



CAUTION

Saved test results and settings may be erased during upgrading. You are recommended to save all test results before upgrading the firmware.

3 WireXpert User Interface

Starting from v7.4, users are required to read and agree to the “End User License Agreement (EULA)” on the first launch or after a firmware upgrade to use WireXpert. The EULA can be found in **[TOOLS] → About Us → Info** after agreeing the first time.

3.1 Touch Screen Layout

The Graphical User Interface (GUI) in version 7.0’s firmware has been updated with a more responsive system and quick-access menus.

WireXpert boots up to the SETUP screen. It is categorized into 5 groups:

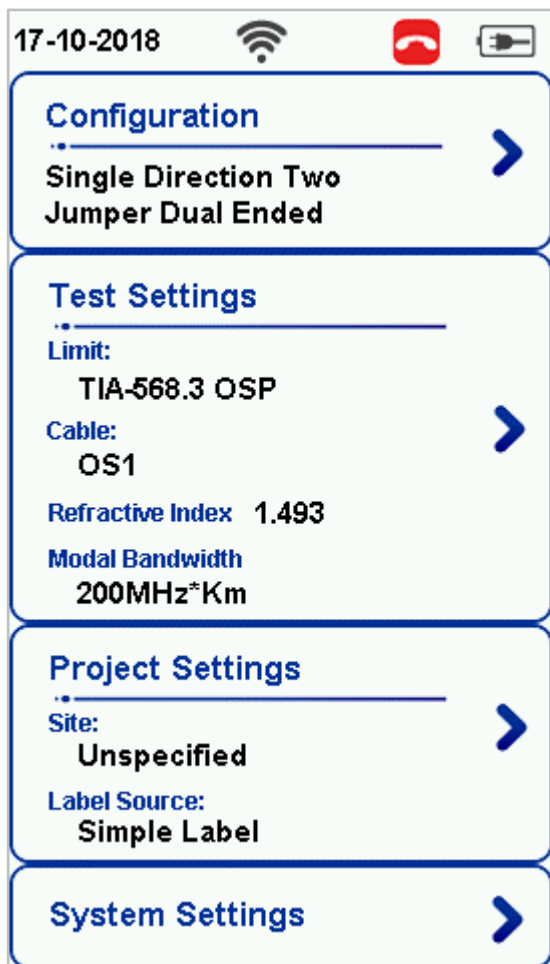

1. Status bar
2. Configuration group
3. Test Settings group
 - *Modal Bandwidth option is available on Multi-mode only.*
4. Project Settings group
5. System Settings group

1. The **Status bar** displays the current date, Wi-Fi connectivity status, USB connectivity status, talk set connectivity status and battery level. Tap icons to change or view setting.
2. The **Configuration** group provides selection on number of jumper(s) referencing is set to, and determine single or bi-directional test is performed during an AUTOTEST.
3. The **Test Settings** group provides results-oriented configurations necessary to perform an AUTOTEST.
4. The **Project Settings** group provides non-results-oriented configurations before performing an AUTOTEST.

5. The **System Settings** group settings provides device, time, localization and device related configurations.

3.2 The One Touch Access Button

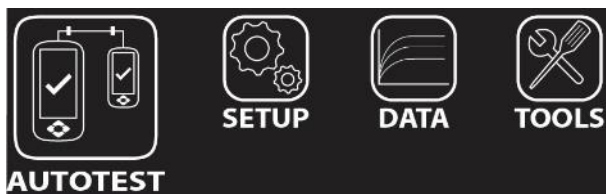

The fundamental philosophy behind the WireXpert User Interface is simplicity in its ease of use. The main functions of the One-Touch access buttons as follows:

3.2.1 The [AUTOTEST] button



The [AUTOTEST] button will perform an immediate certification test on the last configured settings. If no settings were configured, default settings will be used.

Test results will be generated automatically after the test is completed.

You will receive any of the following 4 results after performing AUTOTEST:



Green "PASS" – Good test result in accordance to pre-defined settings.



Red "FAIL" – Unacceptable results with severe disturbance on one or more test parameters.

You will be given the following option after performing an AUTOTEST:

- [Save] test results to device.

An "AUTOTEST" will fail in the event of missing connection between the LOCAL and REMOTE units, wrong settings configured, "dirty" end connectors or broken cables.

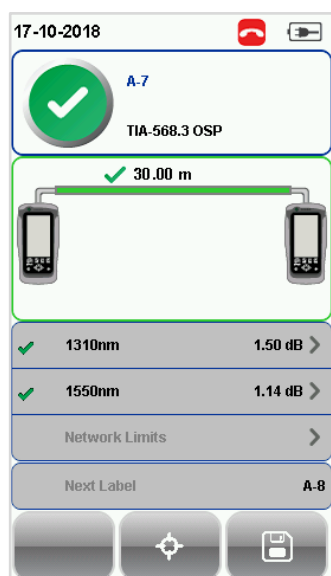

SM Fiber AUTOTEST results

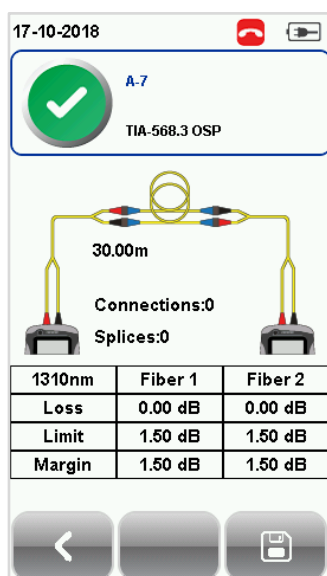

Detailed results for 1310nm

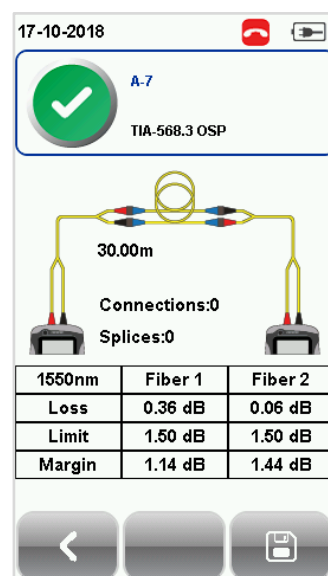

Detailed results for 1550nm

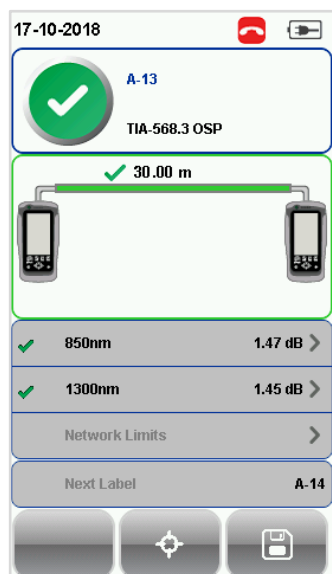

MM Fiber AUTOTEST results

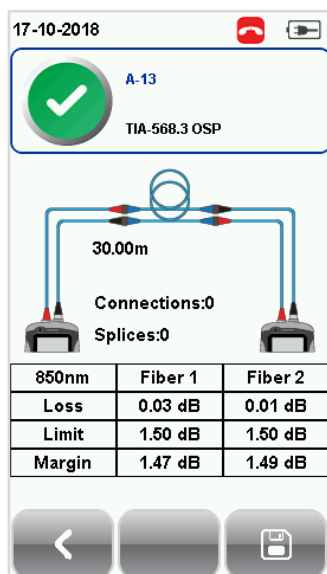

Detailed results for 850nm

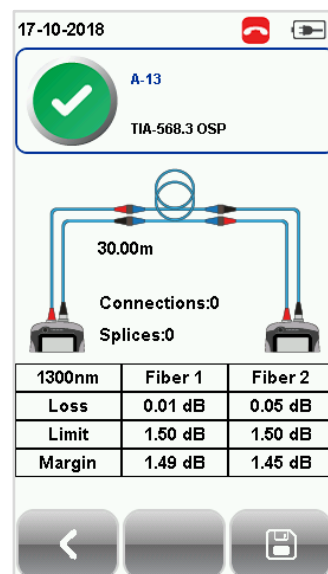

Detailed results for 1310nm

If Bi-direction is selected, swap the TX and RX connections on both ends when prompted.

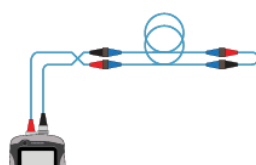
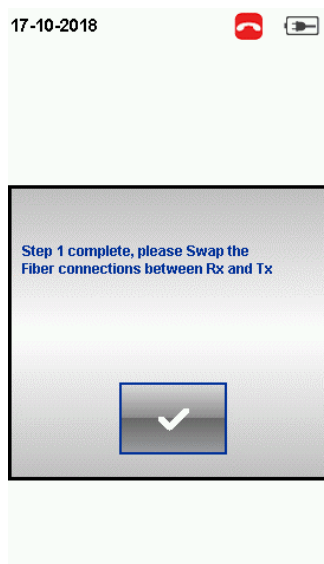

Swapping of TX and RX for Single-ended loopback testing.

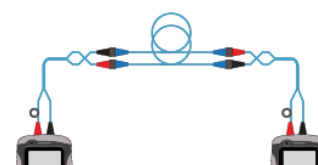

Swapping of TX and RX for Dual-ended testing.



Note

Diagrams and images used are for illustration purposes only and do not represent suggested test values. Reference and test values vary from usage and condition.

3.2.2 The [SETUP] button



The [SETUP] button provides setting options necessary to conduct an AUTOTEST and configure the device.

These options include:

3.2.2.1 Configuration

Configuration provides selection of the number of jumper(s) is used for setting reference on dual or single ended loopback and determines if single or bi-directional test is performed during an AUTOTEST.

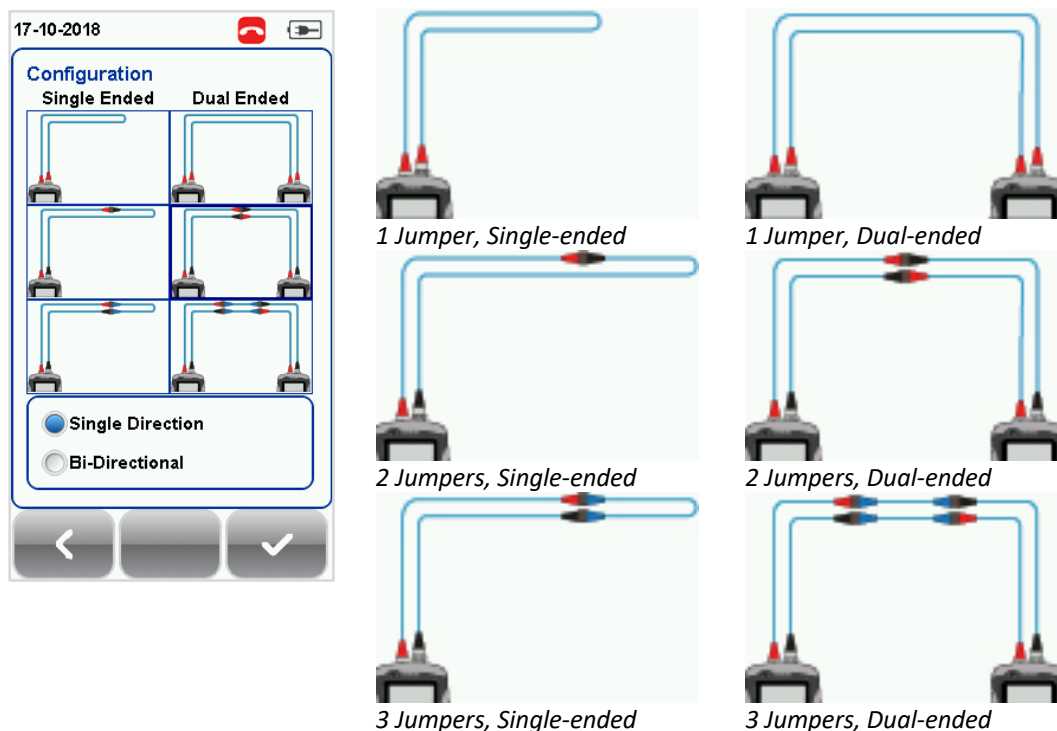

Note

According to the ISO/IEC standards, the 2-jumpers testing method is not compliant, hence the selection for 2-jumpers configuration will be disabled when an ISO limit is selected.

3.2.2.2 Test Settings

Test Settings provides results-oriented configurations necessary to perform an AUTOTEST including:

3.2.2.2.1 Test Limit

Standard Limits: Choose from a list of standards to determine the performance criteria in a given standard. Enter the value for the number of connections, loss per connection, number of splices and loss per splice.

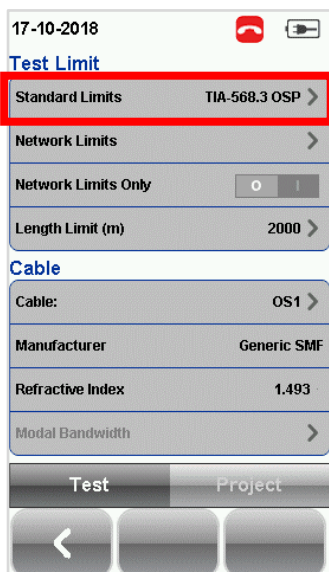

Standard Limits

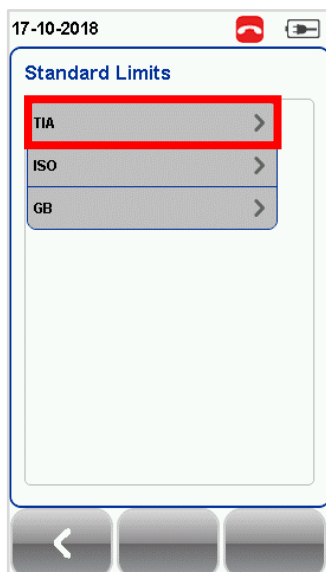

Select "TIA-568.3"

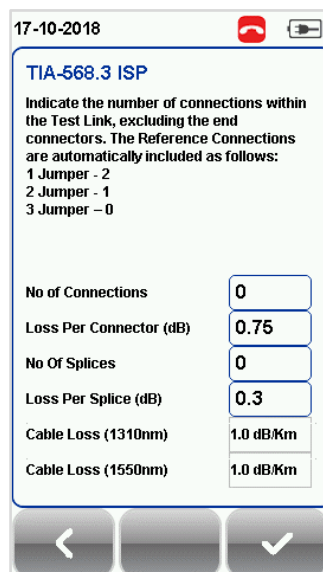

TIA-568.3

Network Limits: Choose from a list of network limits to determine additional specific network testing criteria such as maximum loss in link validation, Ethernet standard, fiber channel or custom limits. Custom limits can be created using spreadsheet software, saved as *.CSV format and loaded to the device. Enable “Network Limits Only” to disable and ignore Standard and Length Limits during test.

Length Limits: Enter fiber length if test criteria require specific fiber length.

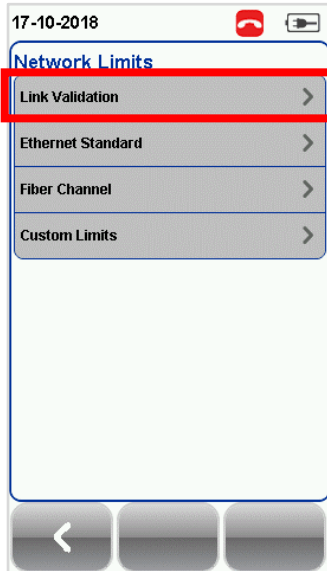

Network Limits

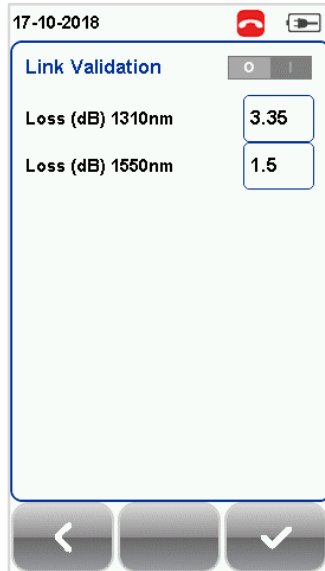

Link Validation for SM

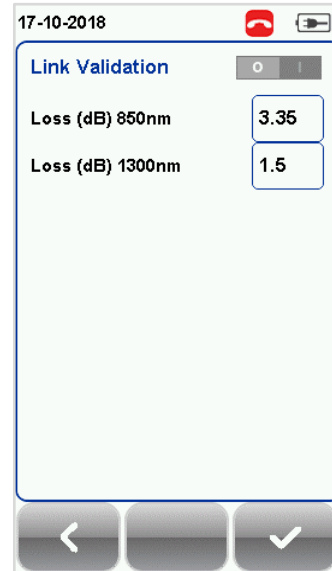

Link Validation for MMEF

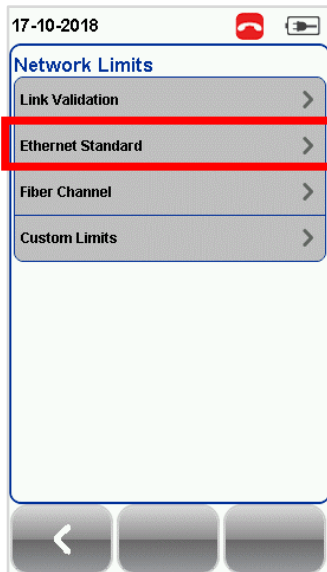

Network Limits

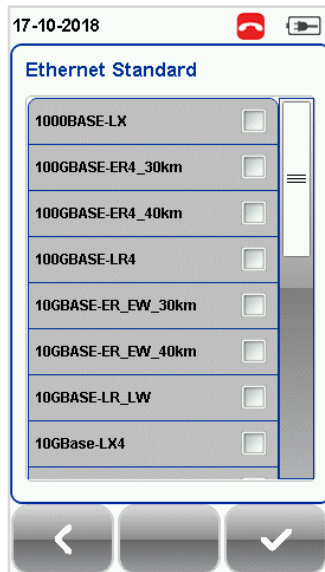

Ethernet Standard for SM

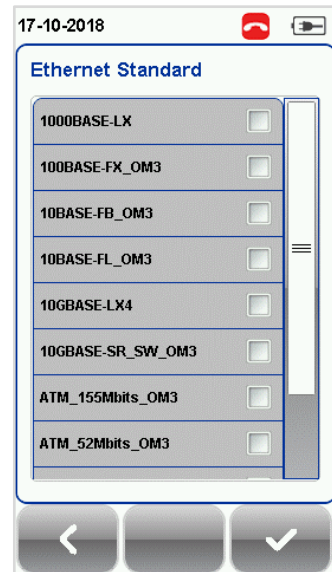

Ethernet Standard for MMEF

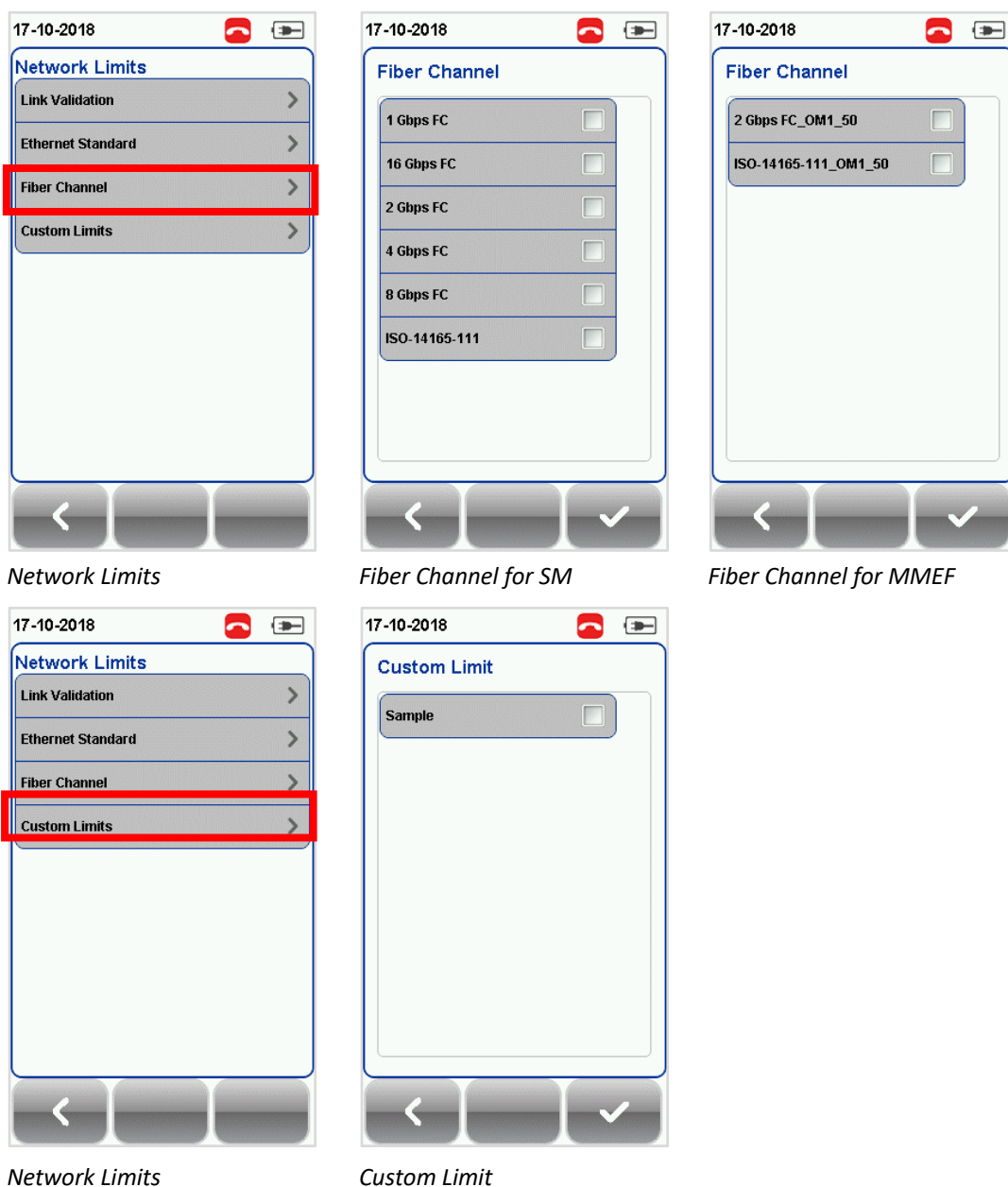

3.2.2.2.2 Cable

Choose from a list of cable manufacturer for more specific test parameters. If unsure of manufacturer, choose **[Generic SMF]** or **[Generic MMF]**, or **[Customized Cable]** to create custom cable.

Customized Cable

Click **[Add]** to add or **[Delete]** to remove customized cable(s) from the customized cable list.

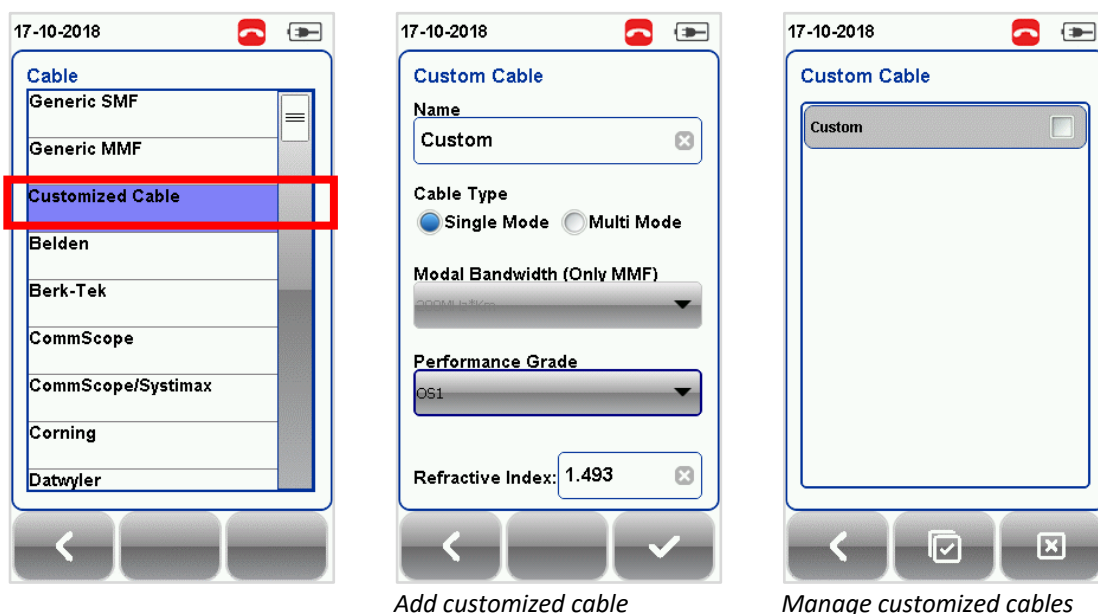

When creating customized cable, determining the cable name, cable type, performance grade and cable's refractive index is required.



WireXpert introduces the **[Manage]** button on version 7.0 firmware. **[Manage]** enables multiple saved items such as sites, operators, customized cables, customized connectors and results to be selected and deleted simultaneously.

3.2.2.2.3 Refractive Index

The refractive index determines the speed light is travelling in the fiber optic. The value is determined by the fiber cable selected.

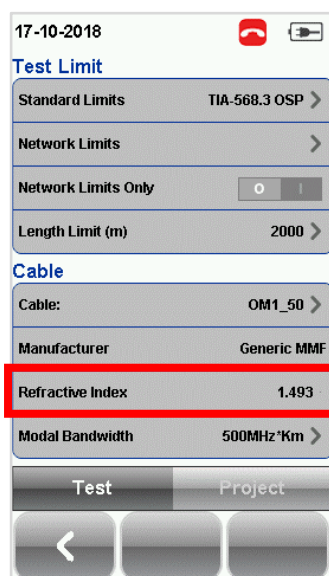

3.2.2.2.4 Modal Bandwidth (Multi Mode only)

Modal bandwidth refers to the signaling rate per distance unit.

Modal bandwidth will be automatically selected when a cable type is selected. Press the **[SETUP]** button → **Test Settings** → **Modal Bandwidth** to manually choose the modal bandwidth of the cable under test.

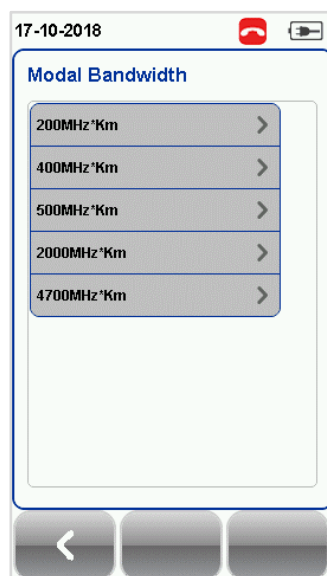
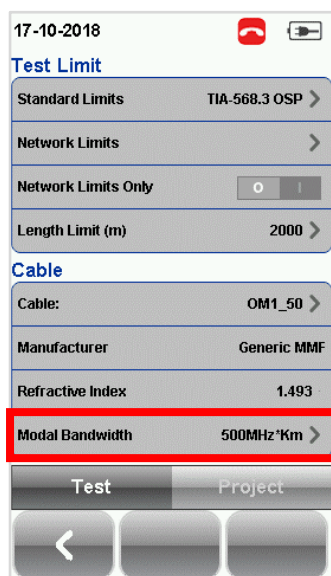

Fiber Type	Core/cladding (μm)	Bandwidth/Length (MHz*km)
OM1	62.5/125	200
OM2	50/125	500
OM3	50/125	2,000
OM4	50/125	4,700

3.2.2.3 Project Settings

Project Settings provides non-results-oriented configurations before performing an AUTOTEST.



User Manuals

Refer “User Manual – Copper Certification Testing” for more information on Project Settings.

3.2.2.4 Label Source



User Manuals

Refer “User Manual – Copper Certification Testing” or “User Guide – List Based Testing” for more information.

List Based Testing

List based testing allows creation of label list in the eXport software on PC and then bring the list to WireXpert. It further allows easy selection of labels from the list to help technician select the cables to be tested quickly. This testing method is carefully optimized for typical test work-flow, and it significantly improves productivity.



User Manuals

Refer “User Guide – List Based Testing” for more information on List Based Testing.

3.2.2.5 System Settings

3.2.2.5.1



User Manuals

Refer “User Manual – Copper Certification Testing” for more information on System Settings.

3.2.3 The [DATA] button



The **[DATA]** button provides archive and data management ability to saved sites and test results. Saved test results can be renamed or deleted in this option. Select **Fiber** → **[View]** to view saved fiber test results. Saved fiber test results can only be viewed in Fiber mode.

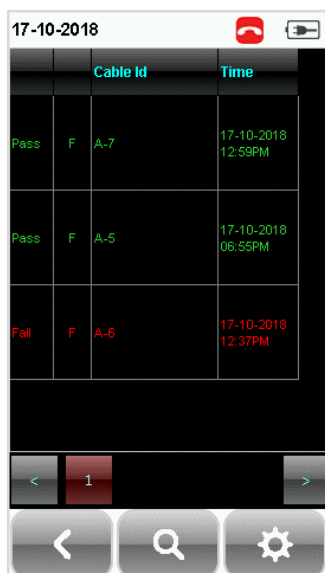
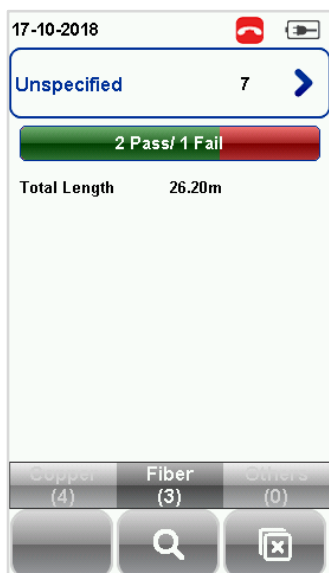

View Results

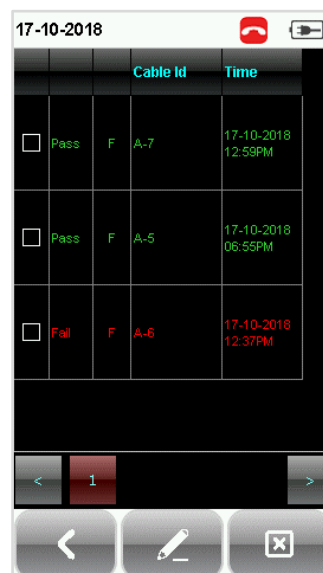

Manage Results



CAUTION

Deleting a site will also delete its containing test results.

3.2.4 The [TOOLS] button



The **[TOOLS]** button provides advanced options for in-depth troubleshooting and expert WireXpert users. These options include:



Requires:
LOCAL and REMOTE

Set Reference – Establish test conditions and exclude the reference cords from the measurement.



Requires:
LOCAL and REMOTE

Power Meter – Measures the power loss from a 850/1300nm or 1310/1550nm wavelength light source.



Requires:
LOCAL or REMOTE

Light Source – Emits 850/1300nm or 1310/1550nm light source to determine loss on a Power Meter.



Requires:
1. LOCAL or REMOTE
2. Inspection Probe[#]

Inspect Fiber – Performs visual verification of fiber's quality using an external scope probe.



Requires:
LOCAL or REMOTE
(MMEF only)

VFL – Visual Fault Locator. Emits light for visual detection of broken fiber location.



Requires:
1. LOCAL MM/MMEF
2. REMOTE MPO

MPO/MTP – Switches device to MPO mode to perform single fiber Power Meter test.



Requires:
LOCAL or REMOTE

About – Displays worldwide contact and End User License Agreement (EULA) information.



Requires:
1. LOCAL & REMOTE
2. License key(s)[#]

Licensing – Performs device upgrade from WireXpert 500 to WireXpert 500+ or/to WireXpert 4500.



Requires:
1. LOCAL only
2. Wi-Fi dongle[#]

Wifi – Enables WireXpert to connect to the Wi-Fi to perform eXport Cloud features.



Requires:
1. LOCAL only
2. eXport Cloud[#]

eXport Cloud – Enables WireXpert to download List Based Testing (*.LBT) and upload project site (*.WSD) files to the eXport Cloud platform. Active network connection is required.



Note

[#] Optional purchase required for feature. Contact Softing IT Networks for more information.



User Manuals

Refer “User Guide – eXport Cloud” for more information on installing and using eXport Cloud.



User Manuals

Refer “User Guide – License Upgrade” for more information on upgrading WireXpert 500 to WireXpert 500+ or/to WireXpert 4500.

4 Setting Reference

It is necessary to perform a set reference measurement before each test. If there is a mismatch in firmware versions, WireXpert will require user to perform a set reference.

The setup varies depending on the number of jumper(s) reference is selected.



Note

Diagrams and images used are for illustration purposes only. Reference and test values vary from usage and condition.

Procedures are applicable for SM, MM and MMEF fiber setups.



Hint

Use reference cords provided in the kit. Connect the cords by following the color of the connectors as shown in each configuration.

Connect cords with red connectors to the TX port and black connectors to the RX ports of the adapters.

4.1 One jumper Dual-ended

1. Connect TX1 to the LOCAL TX port and RX1 to the REMOTE RX port.
2. Connect TX2 to the REMOTE TX port and RX2 to LOCAL RX port.

Please ensure the fiber cables are cleaned using the cleaning kit provided in the kit.



3. Press the **[SETUP]** button → **Configuration** → **One Jumper** from Dual-Ended column. Select Single or Bi direction depending on requirement.

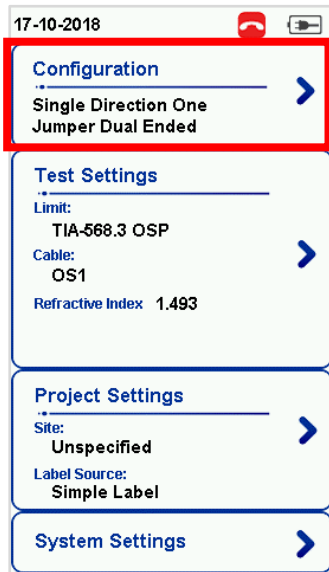

[SETUP]

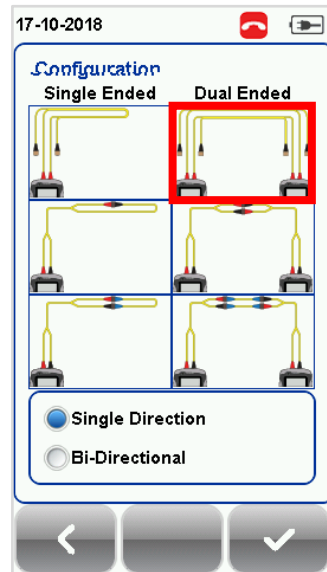

Single Mode [Configuration]

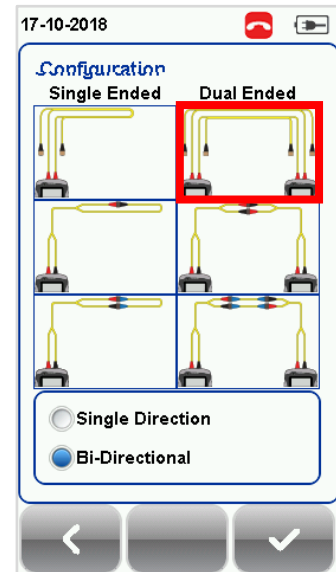

Single Mode [Configuration]

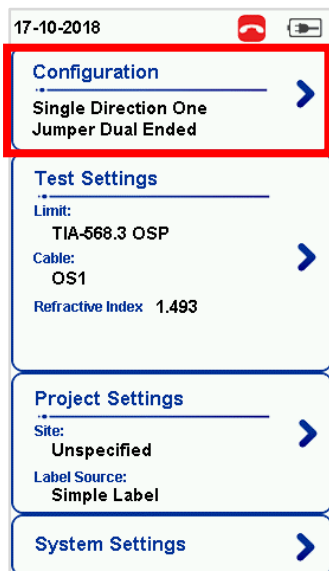

[SETUP]

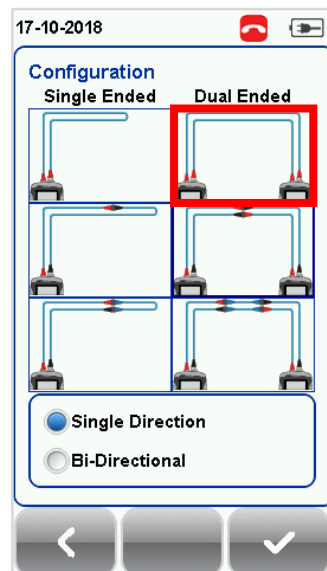

Multimode EF [Configuration]

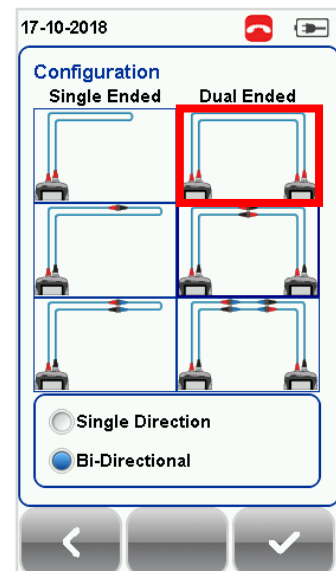

4. Press the [TOOLS] button → Set Reference and press the [Ok] button to set reference.

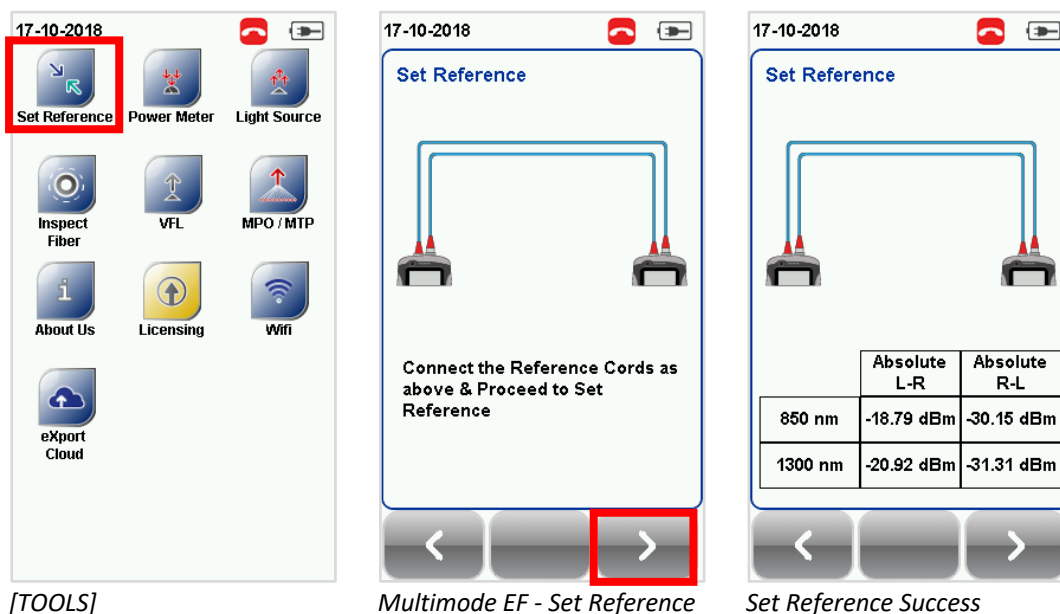
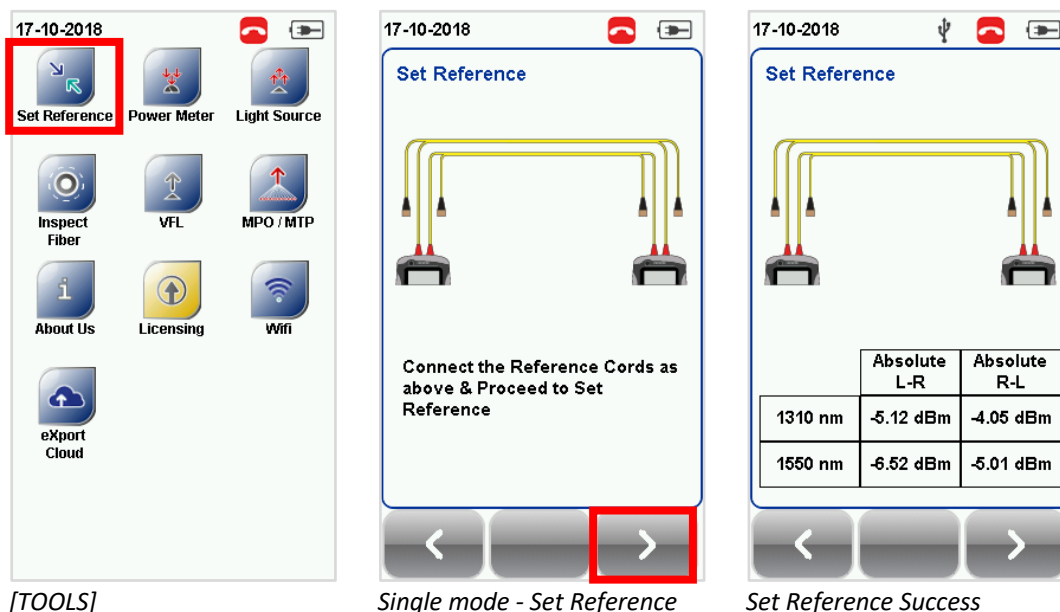

5. Check that the Set Reference result is between **-3 to -9dBm** for Single Mode and **-18 to -20dBm** for Encircled Flux Multi Mode.

4.1.1 Verification Test

To verify reference has been set correctly, setup the following connection.

1. Connect TX1 to the LOCAL TX port and RX1 to coupler 1.
2. Connect RX3 to the LOCAL RX port and TX3 to coupler 2.
3. Connect TX2 to the REMOTE TX port and RX2 to coupler 2.
4. Connect RX4 to the REMOTE RX port and TX4 to coupler 1.

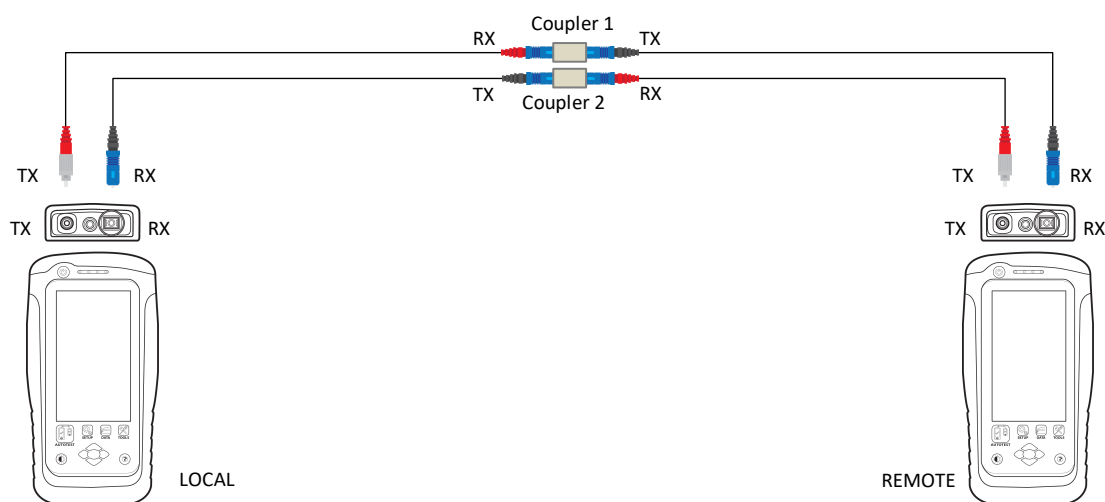

5. Press the **[AUTOTEST]** button.
6. Check that the result passes with the following results:
 - Single Mode – 0.3 dB
 - EF compliant Multi-mode – 0.15 dB

4.2 Two jumpers Dual-ended,

1. Connect TX1 to the LOCAL TX port and RX1 to coupler 1.
2. Connect RX3 to the LOCAL RX port and TX3 to coupler 2.
3. Connect TX2 to the REMOTE TX port and RX2 to coupler 2.
4. Connect RX4 to the REMOTE RX port and TX4 to coupler 1.

Please ensure the fiber cables are cleaned using the cleaning kit provided in the kit.

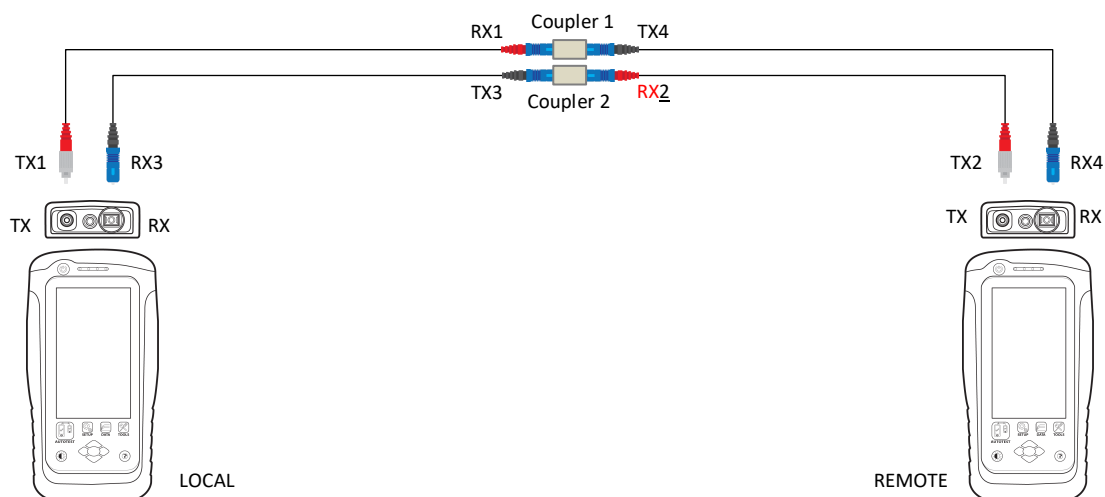

5. Press the **[SETUP]** button → **Configuration** → **Two Jumpers** from Dual-Ended column. Select Single or Bi direction depending on requirement.

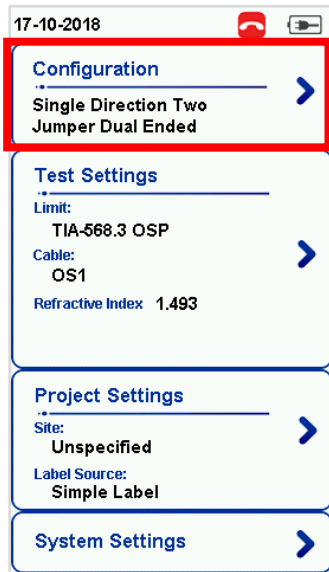

[SETUP]

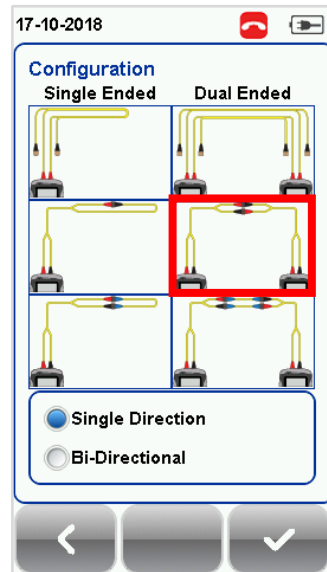

Single Mode [Configuration]

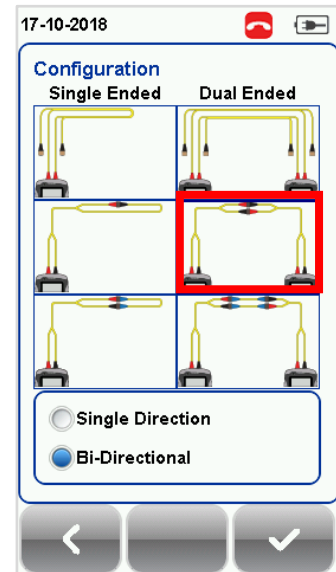

Single Mode [Configuration]

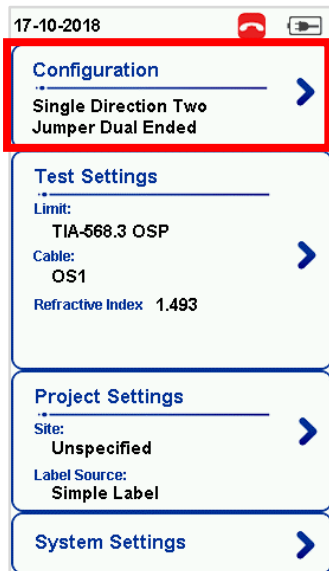

[SETUP]

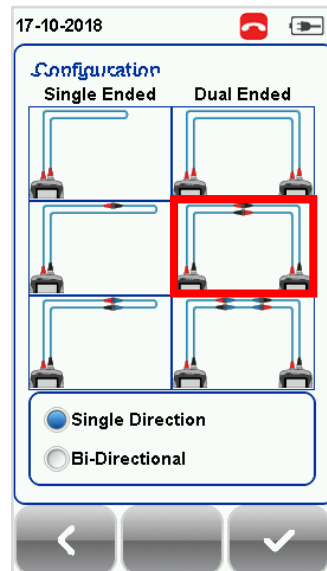

Multimode EF [Configuration]

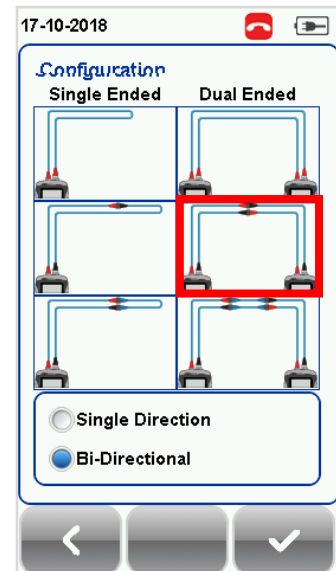

- Press the [TOOLS] button → **Set Reference** and press the [OK] button to set reference.

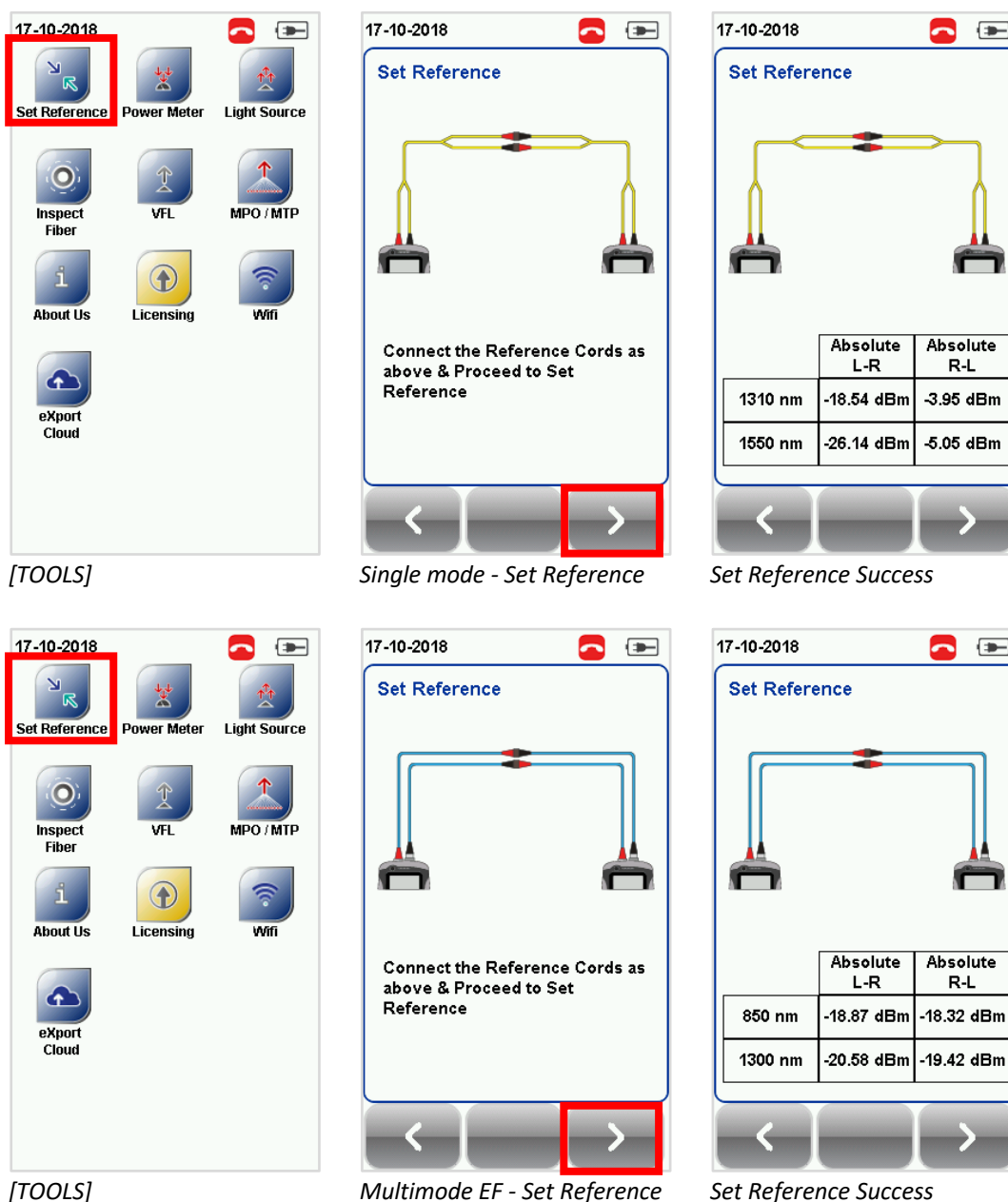

7. Check that the Set Reference result is between **-3 to -9dBm** for Single Mode and **-18 to -20dBm** for Encircled Flux Multi Mode.

4.3 Three jumpers Dual-ended,

1. Connect TX1 to the LOCAL TX port and RX1 to coupler 1.
2. Connect RX3 to the LOCAL RX port and TX3 to coupler 2.
3. Connect TX2 to the REMOTE TX port and RX2 to coupler 4.
4. Connect RX4 to the REMOTE RX port and TX4 to coupler 3.
5. Connect one end of your jumper (TX5) to coupler 1 and the other end (RX5) to coupler 3.
6. Connect one end of the other jumper (TX6) to coupler 4 and the other end (RX6) to coupler 2.

Please ensure the fiber cables are cleaned using the cleaning kit provided in the kit.

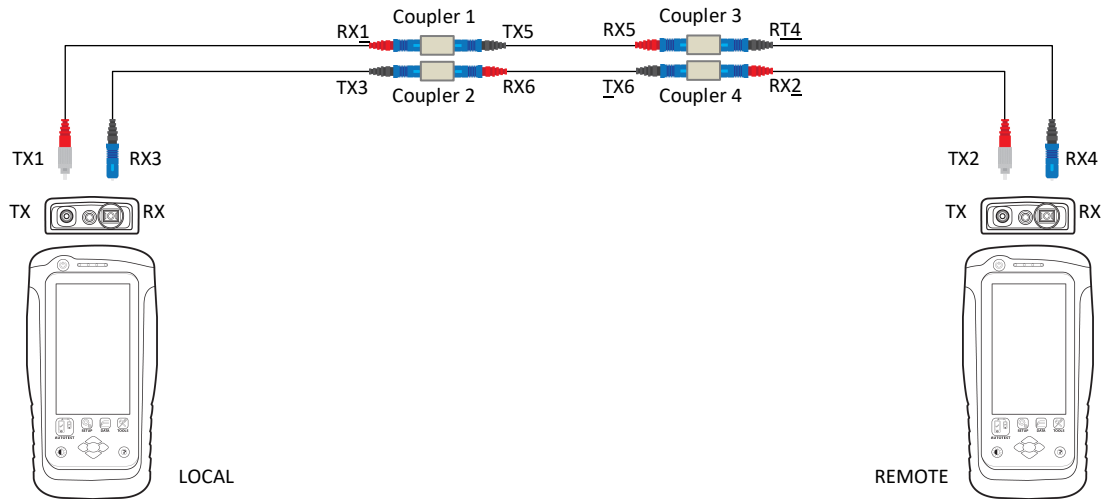

- Press the **[SETUP]** button → **Configuration** → **Three Jumpers** from Dual-Ended column. Select Single or Bi direction depending on requirement.

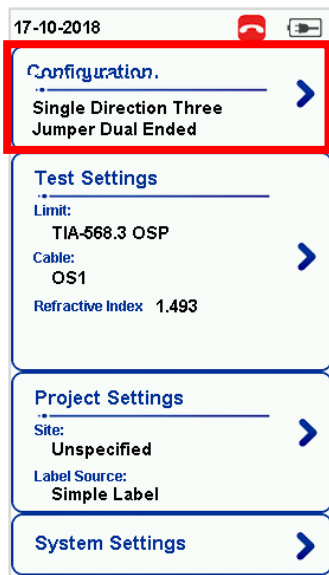

[SETUP]

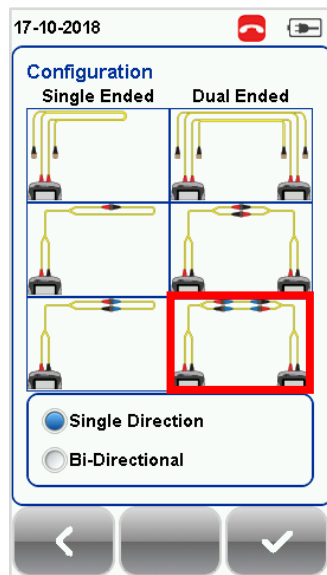

Single Mode [Configuration]

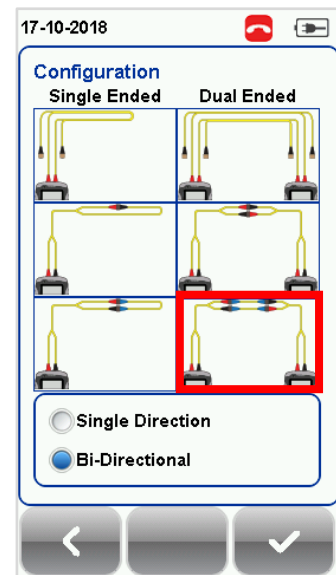

Single Mode [Configuration]

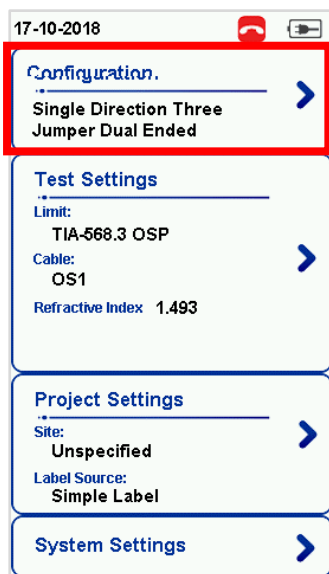

[SETUP]

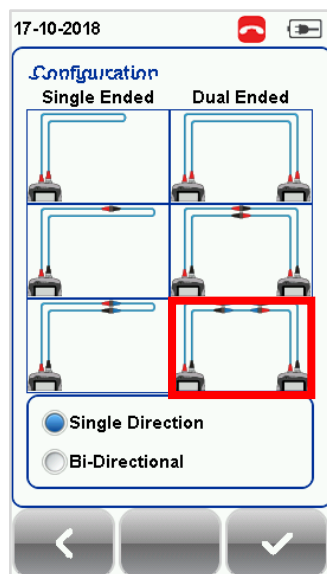

Multimode EF [Configuration]

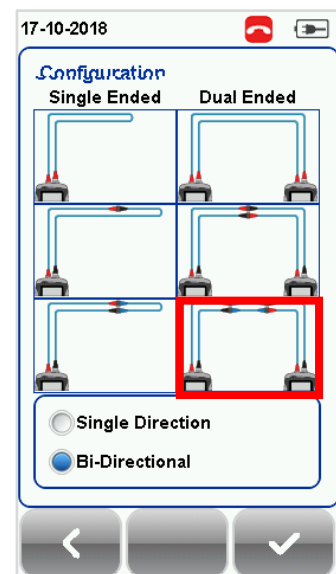

8. Press the [TOOLS] button → **Set Reference** and press the [OK] button to set reference.

Single mode – Set Reference

	Absolute L-R	Absolute R-L
1310 nm	-18.85 dBm	-25.66 dBm
1550 nm	-25.88 dBm	-26.95 dBm

Multimode EF – Set Reference

	Absolute L-R	Absolute R-L
850 nm	-18.85 dBm	-18.48 dBm
1300 nm	-20.79 dBm	-19.70 dBm

9. Check that the Set Reference result is between **-3 to -9dBm** for Single Mode and **-18 to -20dBm** for Encircled Flux Multi Mode.

4.4 One jumper Single-ended Loopback

1. Connect the TX1 and RX1 ends of the reference cord to the TX port RX port of the adapter respectively.
Please ensure the fiber cables are cleaned using the cleaning kit provided in the kit.

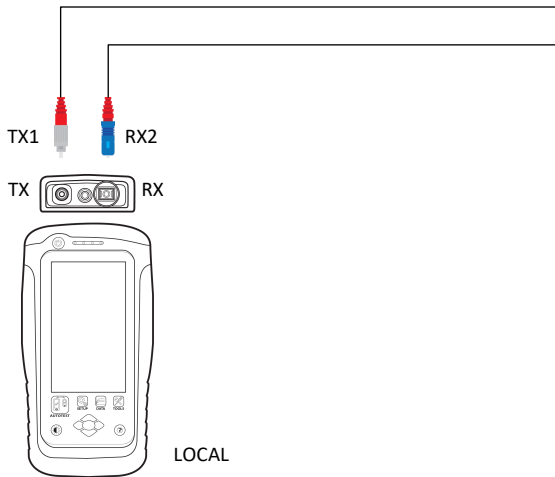

2. Press the **[SETUP]** button → **Configuration** → **One Jumper** from Single-Ended column. Select Single or Bi direction depending on requirement.

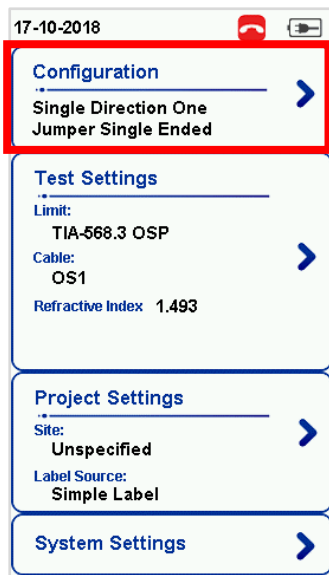

[SETUP]

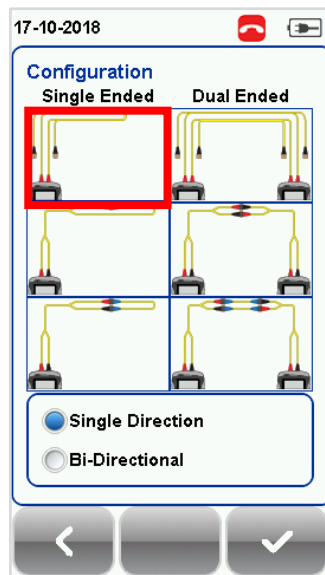

Single Mode [Configuration]

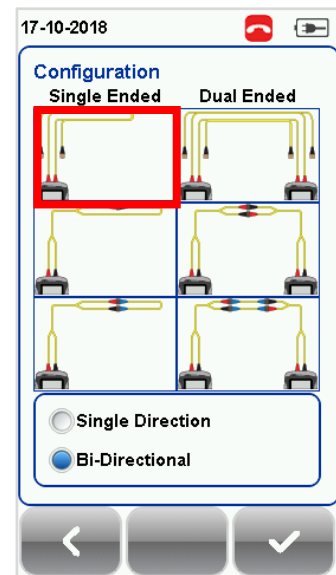

Single Mode [Configuration]

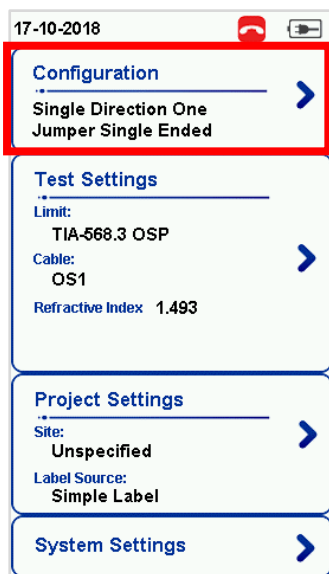

[SETUP]

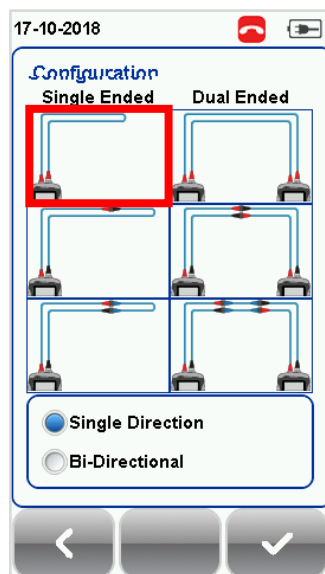

Multimode EF [Configuration]

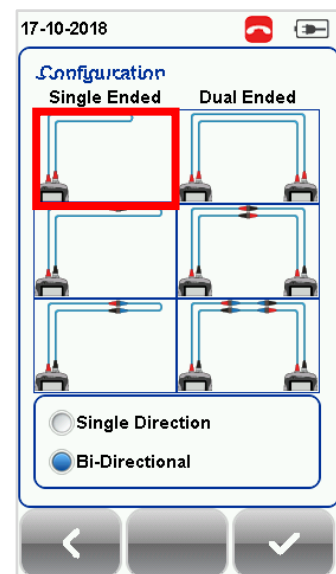

3. Press the **[TOOLS]** button → **Set Reference** and press the **[Ok]** button to set reference.

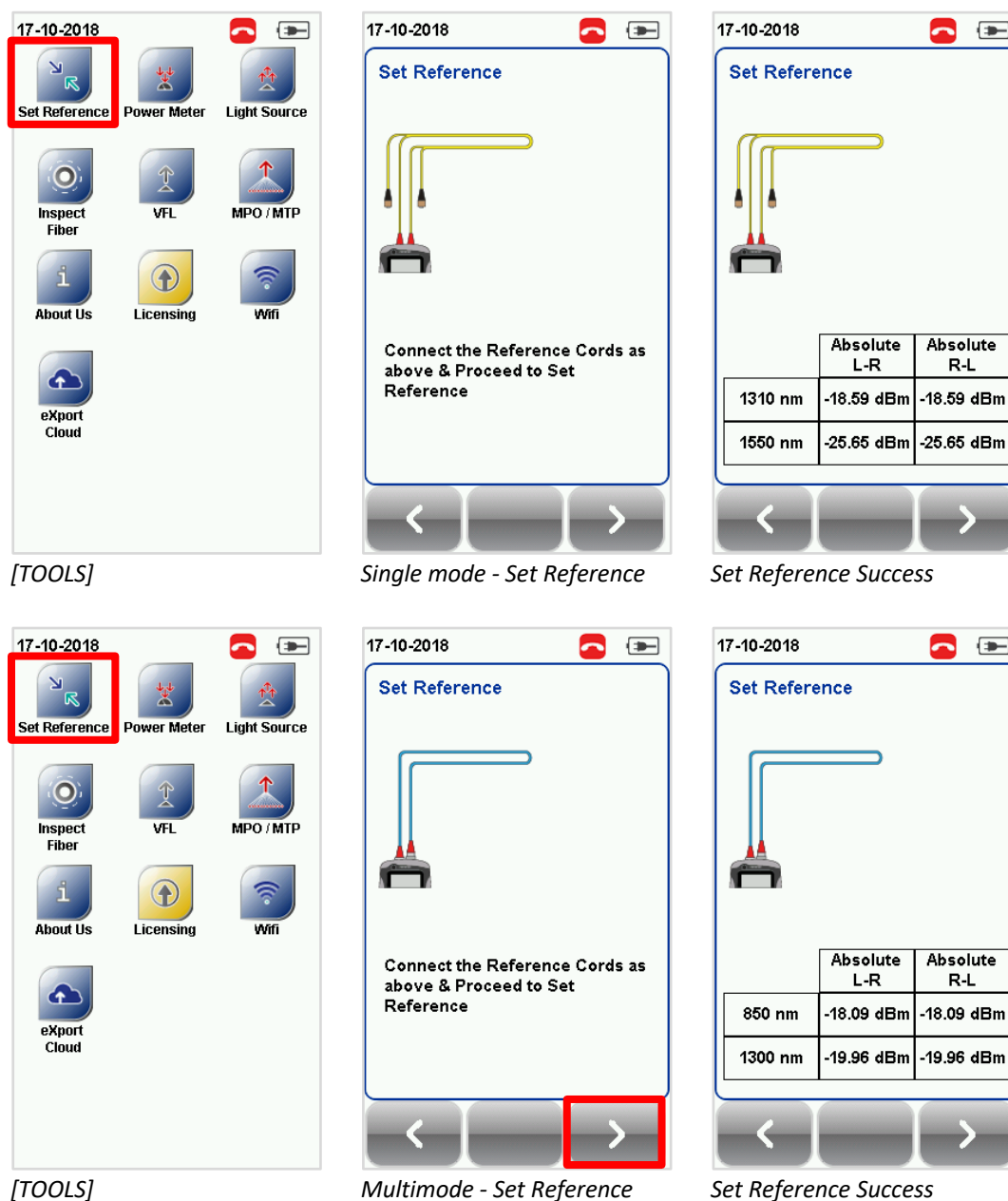

4. Check that the Set Reference result is between **-3** to **-9dBm** for Single Mode and **-18** to **-20dBm** for Encircled Flux Multi Mode.

4.5 Two jumpers Single-ended Loopback

1. Connect TX1 to the TX port and RX1 to one end of coupler 1.
2. Connect RX2 to the RX port and TX2 to the other end of coupler 1.

Please ensure the fiber cables are cleaned using the cleaning kit provided in the kit.

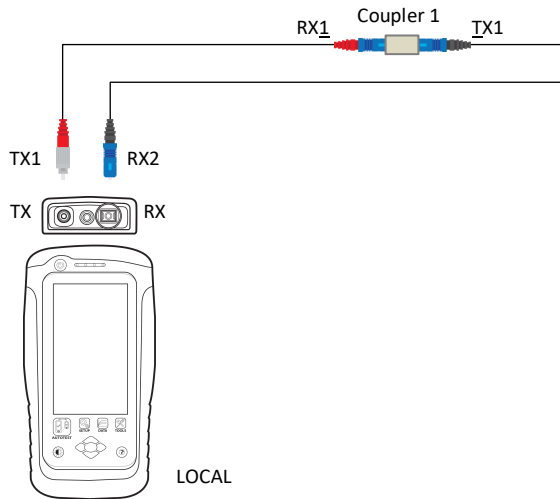

3. Press the **[SETUP]** button → **Configuration** → **Two Jumpers** from Single-Ended column. Select Single or Bi direction depending on requirement.

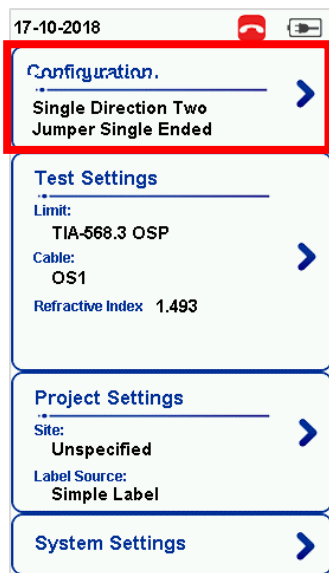

[SETUP]

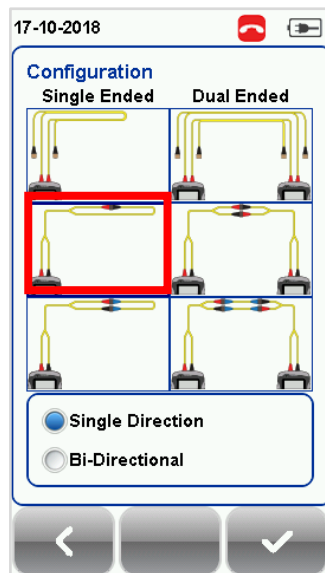

Single Mode [Configuration]

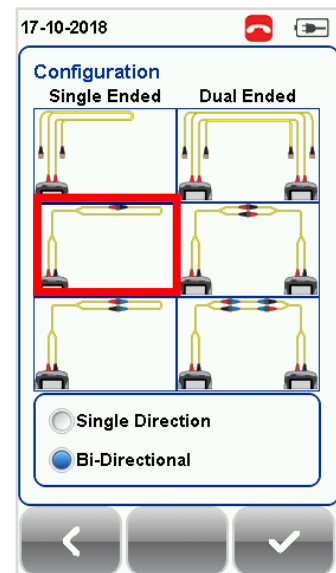

Single Mode [Configuration]

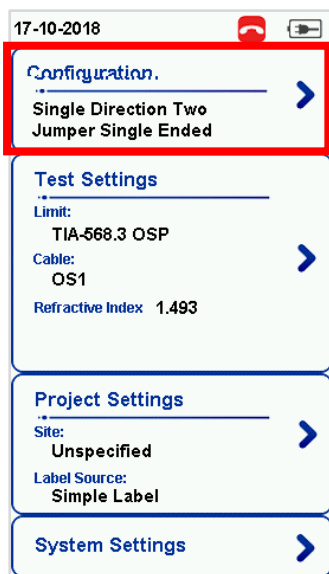

[SETUP]

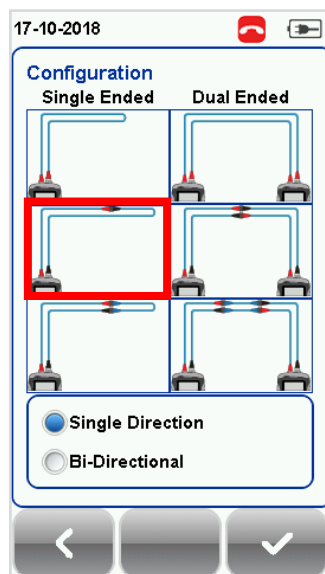

Multimode EF [Configuration]

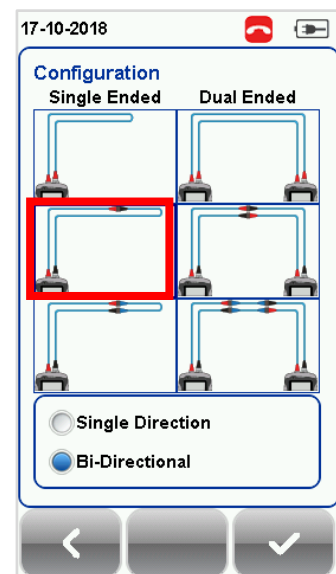

4. Press the **[TOOLS]** button → **Set Reference** and press the **[Ok]** button to set reference.

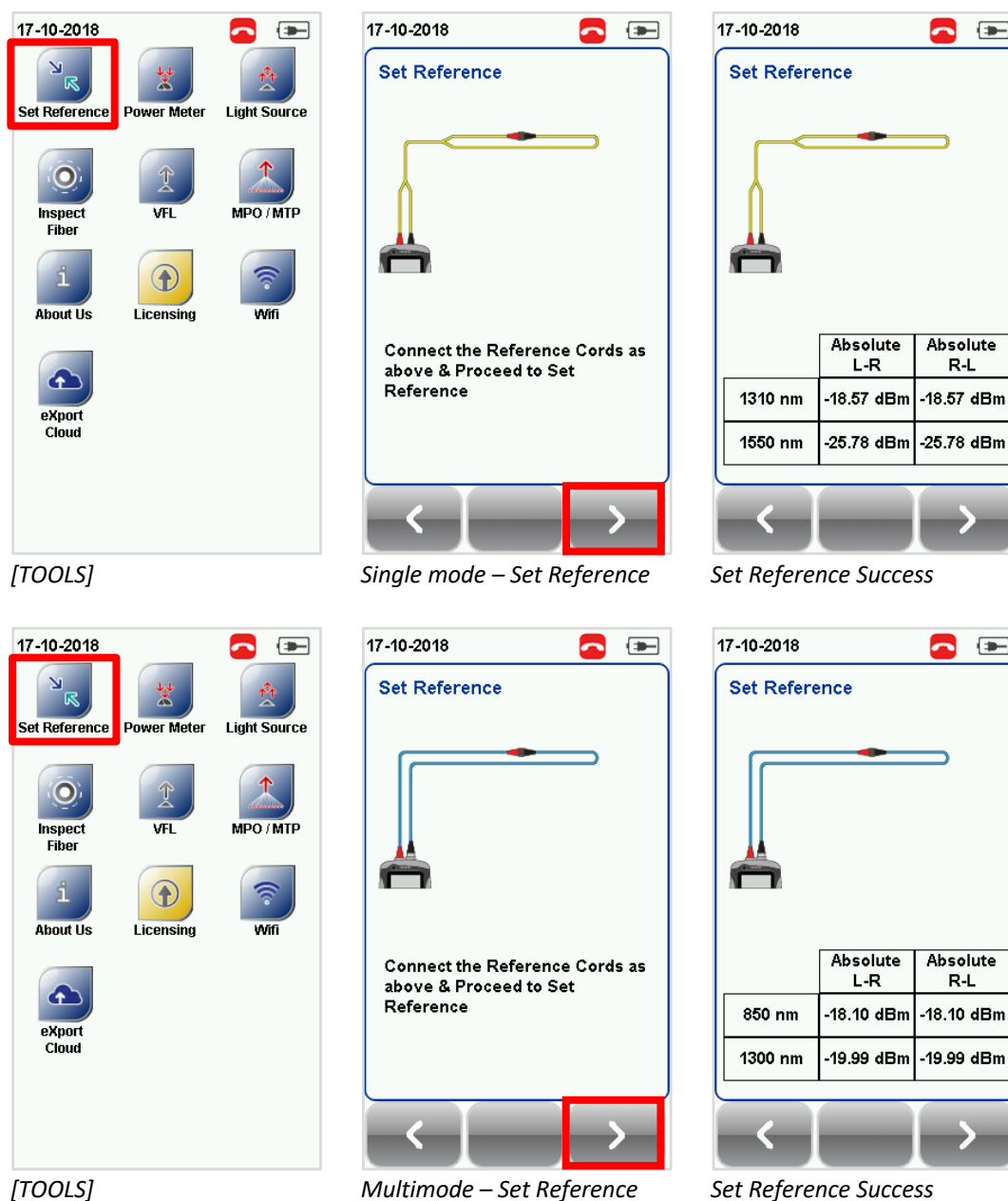

5. Check that the Set Reference result is between **-3** to **-9dBm** for Single Mode and **-18** to **-20dBm** for Encircled Flux Multi Mode.

4.6 Three jumpers Single-ended Loopback

1. Connect TX1 to the TX port and RX1 to one end of coupler 1.
2. Connect RX2 to the RX port and TX2 to the other end of coupler 2.
3. Connect one end of your jumper (TX3) to coupler 1 and the other end (RX3) to coupler 2.

Please ensure the fiber cables are cleaned using the cleaning kit provided in the kit.

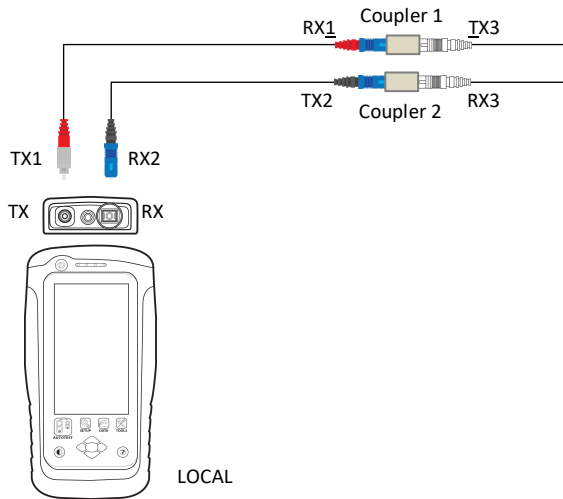

4. Press the **[SETUP]** button → **Configuration** → **Three Jumpers** from Single-Ended column. Select Single or Bi direction depending on requirement.

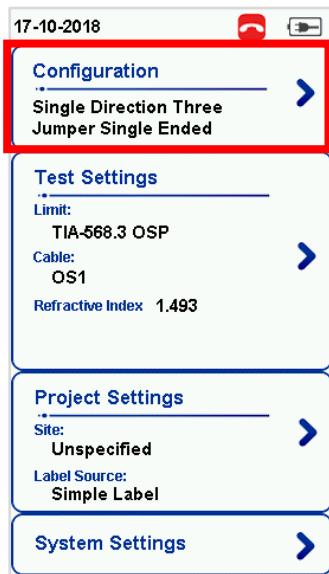

[SETUP]

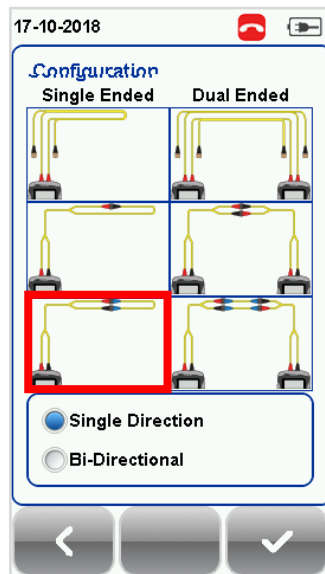

Single Mode [Configuration]

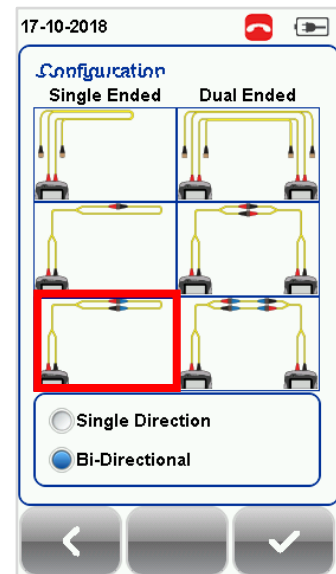

Single Mode [Configuration]

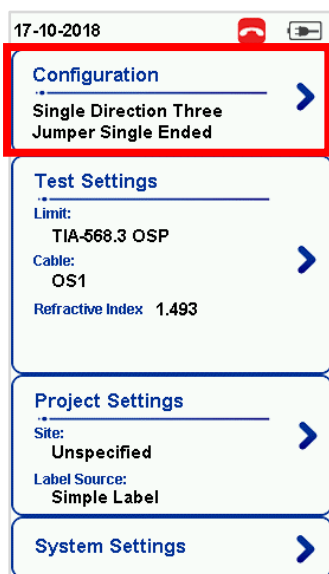

[SETUP]

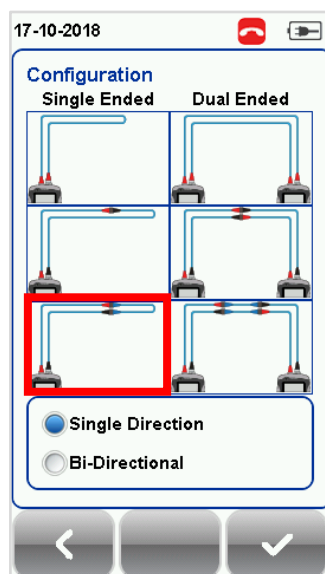

Multimode EF [Configuration]

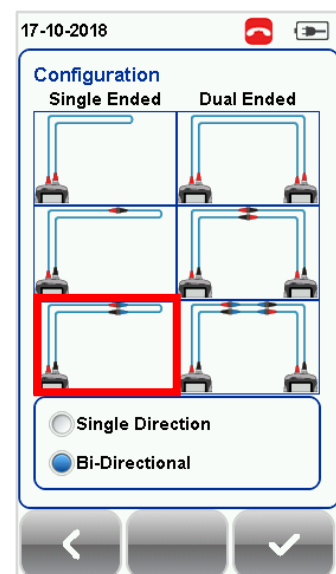

5. Press the **[TOOLS]** button → **Set Reference** and press the **[Ok]** button to set reference.

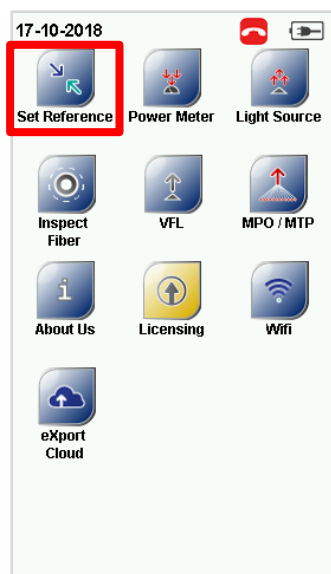

[TOOLS]

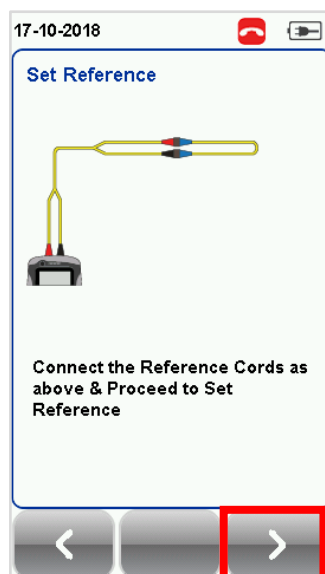

Single mode – Set Reference

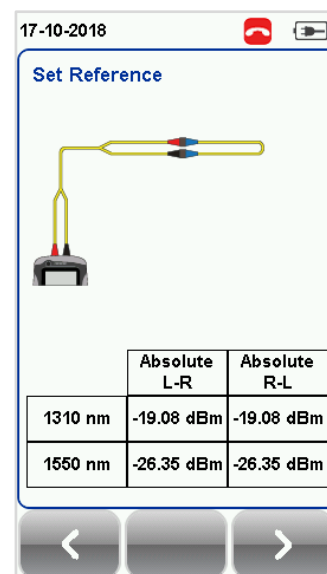

Set Reference Success



[TOOLS]

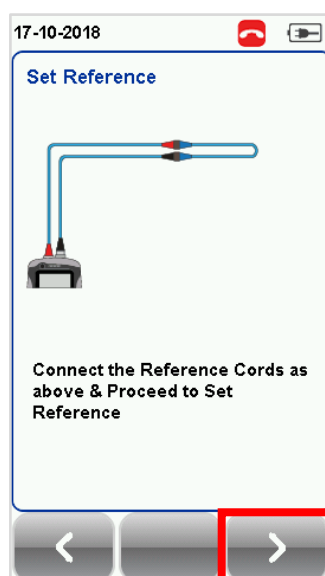

Multimode – Set Reference

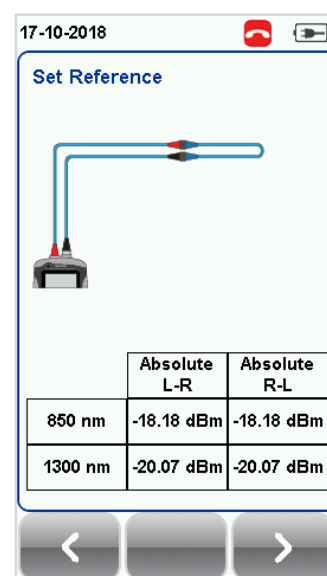

Set Reference Success

6. Check that the Set Reference result is between **-3 to -9dBm** for Single Mode and **-18 to -20dBm** for Encircled Flux Multi Mode.



Hint

Set Reference will fail in the event of:

- Adapter probe mismatch
- Firmware version mismatch
- No connection between LOCAL and REMOTE units

**Note**

According to the ISO/IEC standards, the 2-jumpers testing method is not a recognized procedure, hence the selection for 2-jumpers configuration will be disabled when an ISO limit is selected.

5 Configuring an AUTOTEST

5.1 Setting up WireXpert

After configuring the system settings, follow these steps to set up an AUTOTEST.

1. Press the **[SETUP]** button → **Project Settings**.
 - a. **Site** – Create or select a Site.
 - b. **Operator** – Create or select an Operator.
 - c. **Label Source** – Select cable labeling scheme. Load labels from USB flash drive if using List Based Testing (LBT).
 - d. **AutoSave** – Enable option for WireXpert to auto save every PASS result.
 - e. **Next Label** – To indicate the name of the next result.
2. Press the **[SETUP]** button → **Configuration** to select the number of jumper(s) is used for setting reference on dual or single ended loopback and determines if single or bi-directional test is performed during an AUTOTEST.
3. Manual Setup – Press the **[SETUP]** button → **Test Settings**
 - a. **Test Limit** – Select a test limit.
 - b. **Cable** – Create a custom or select cable from list. Select **[Generic]** if unsure.
 - c. **Refractive Index** – Display the speed of the light in the optic fiber.
 - d. **Modal Bandwidth** - Choose the modal bandwidth of the cable under test. Leave option unchanged if unsure.

Please ensure you have the following components before conducting the test:

- WireXpert, LOCAL&REMOTE units (WX4500 or WX500-FIBER)
- Single Mode Testing Kit (WX_AD_SM2) OR
- Encircled Flux Multi-Mode Testing Kit (WX_AD_EF_MM2)



WX_AD_SM2



WX_AD_EF_MM2

5.2 Testing Guide for Dual-ended Testing

1. Connect TX1 to the LOCAL TX port and RX1 to coupler 1 of link under test.
2. Connect RX3 to the LOCAL RX port and TX3 to coupler 2 of link under test.
3. Connect TX2 to the REMOTE TX port and RX2 to coupler 4 of link under test.
4. Connect RX4 to the REMOTE RX port and TX4 to coupler 3 of link under test.
5. Connect the link to be tested (TX5) to coupler 1 and the other end (RX5) to coupler 3.
6. Connect the other link to be test (TX6) to coupler 4 and the other end (RX6) to coupler 2.

Please ensure the fiber cables are cleaned using the cleaning kit provided in the kit.

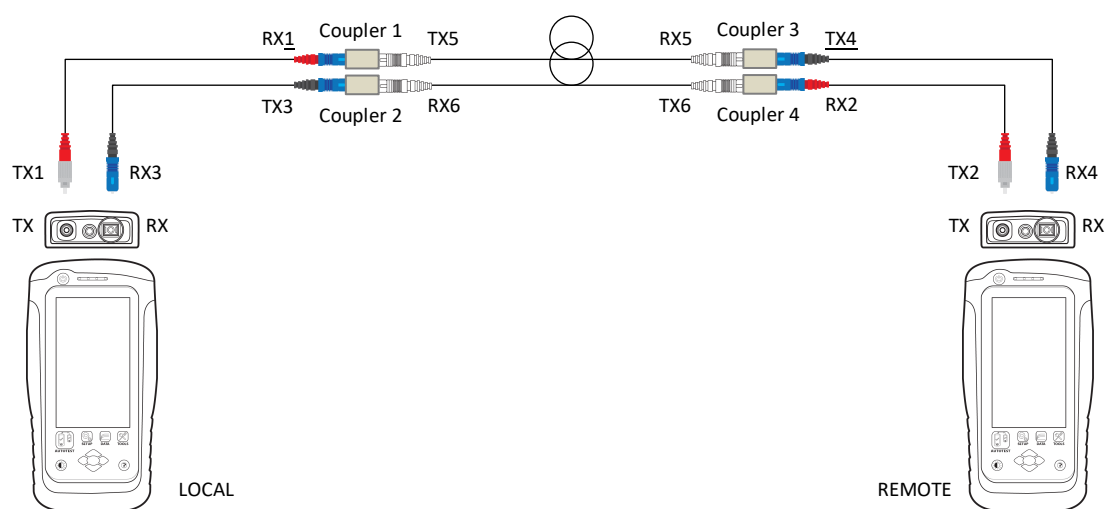

7. Press the **[AUTOTEST]** button to begin AUTOTEST.
8. If Bi-Direction measurement is selected, swap the position of RX1 and TX3, TX4 and RX2.
9. Click **[STEP 2]** to continue test.

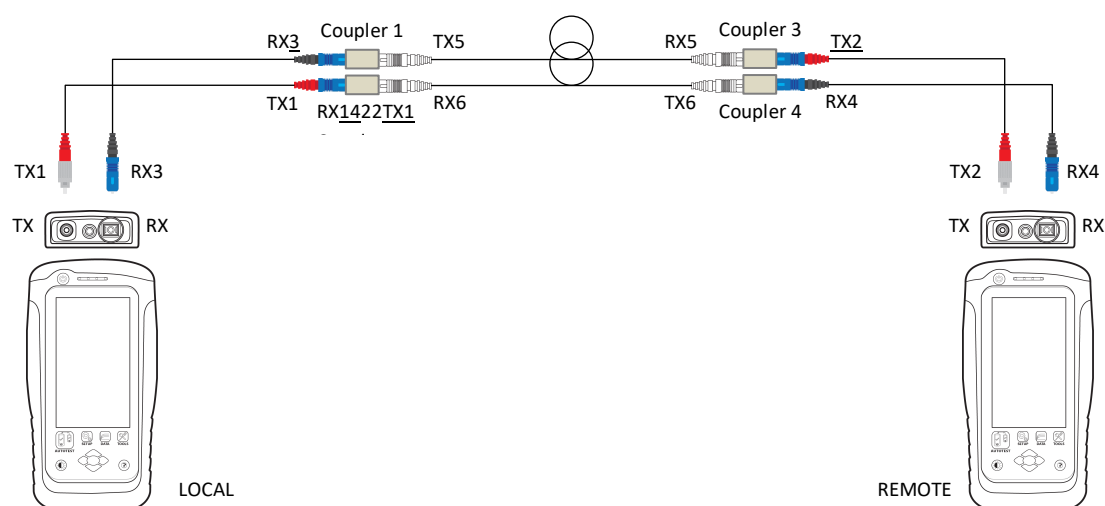

10. Select “850nm” or “1300nm” for Multi-mode or “1310nm” or “1550nm” for Single Mode to check the Loss, Limit and Margin of the fiber setup at the respective wavelength.

5.3 Testing Guide for Dual-ended Testing

1. Connect TX1 to the LOCAL TX port and RX1 to coupler 1 of link under test.
2. Connect RX2 to the LOCAL RX port and TX2 to coupler 2 of link under test.
3. Connect one end of a reference cord (TX3) to coupler 3 of link under test.
4. Connect the other end of the reference cord (RX3) to coupler 4 of link under test.
5. Connect the link to be tested (TX4) to coupler 1 and the other end (RX4) to coupler 3.
6. Connect the link to be tested (TX5) to coupler 4 and the other end (RX5) to coupler 2.

Please ensure the fiber cables are cleaned using the cleaning kit provided in the kit.

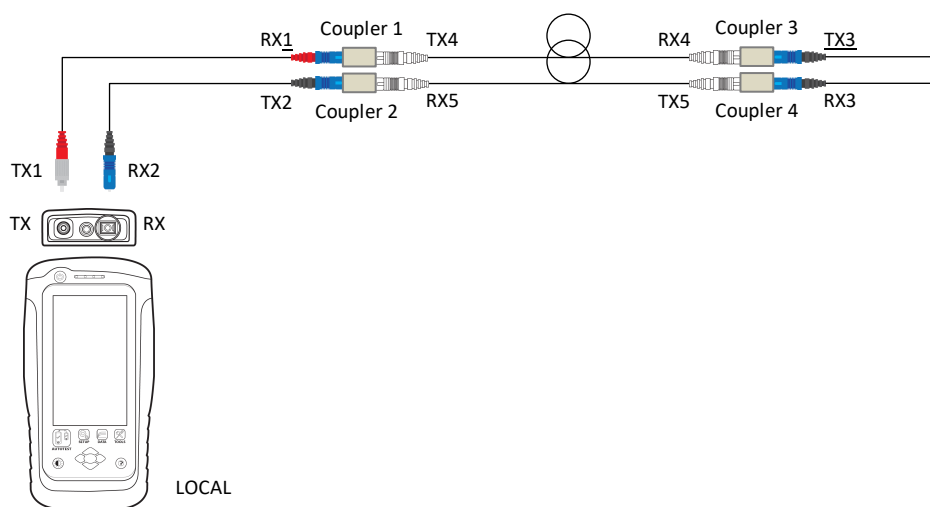

7. Press the **[AUTOTEST]** button to begin AUTOTEST.
8. If Bi-Direction measurement is selected, swap the position of RX1 and TX2.

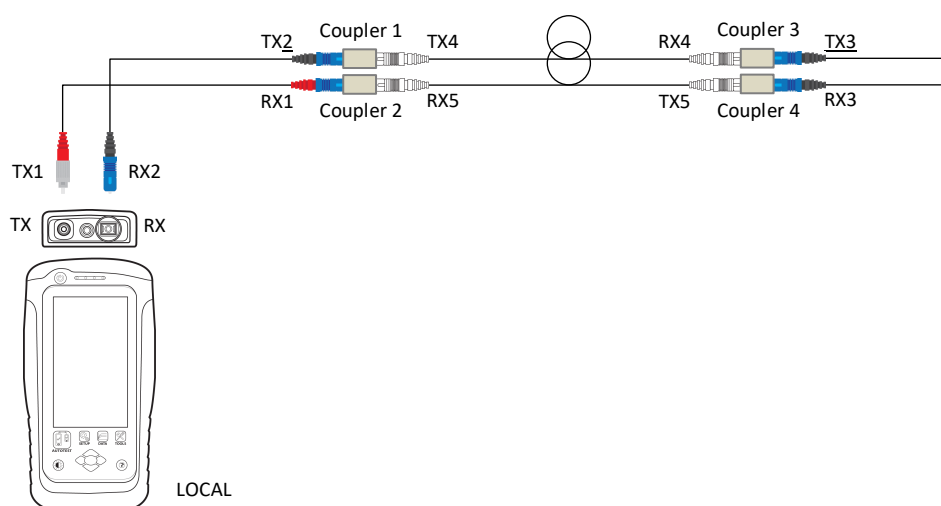

9. Click **[STEP 2]** to continue test.
10. Select "850nm Margin" or "1310nm Margin" to check the Loss, Limit and Margin of the fiber setup at the respective wavelength.

6 Performing an AUTOTEST

6.1 Understanding AUTOTEST

Press the **[AUTOTEST]** button once settings and limits have been selected. WireXpert will use the last configuration or factory settings to perform the AUTOTEST if new settings are not configured.

WireXpert will display summarized result with PASS or FAIL once AUTOTEST is completed. Press the **[View]** details button to view the comprehensive result or the **[Save]** button to save the results.

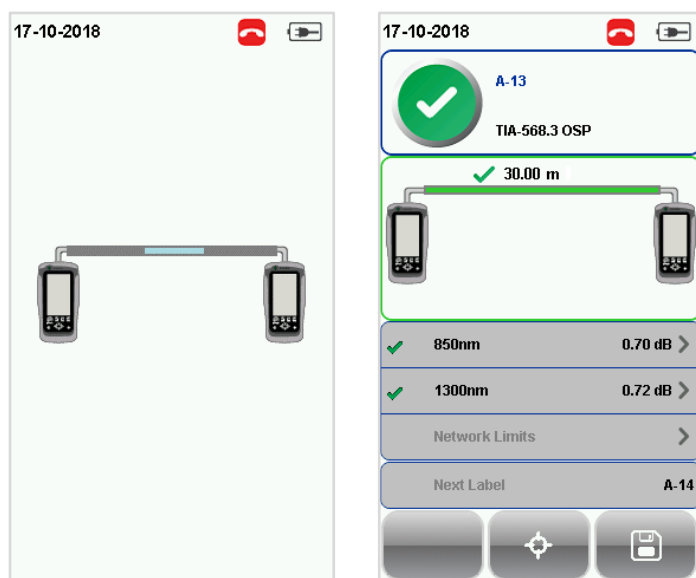

AUTOTEST in progress

AUTOTEST complete

Click on the parameter to display a more comprehensive individual result.

In detailed view, loss from the LOCAL to the REMOTE unit, Limit and Margin will be displayed for each wavelength for both Single and Multi-mode. If Bi-directional test is selected at the configuration settings, test result for loss from REMOTE to LOCAL will be displayed.

Depending on installation requirements, additional tests in line with the application standard will be performed during an AUTOTEST if Ethernet Standard and/or Fiber Channel is selected. To perform additional application standard test, press the **[SETUP]** button → **Test Settings** → **Network Limits**.

WireXpert will perform a separate test based on the loss value input if Link Validation is selected.

Select the **[View Reference]** button to view the reference value that has been set prior to the AUTOTEST. If another set reference is performed after an AUTOTEST, the latest reference value will be used for the subsequent AUTOTESTs.

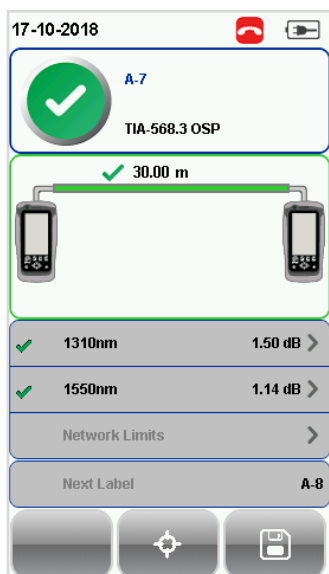

Single Mode

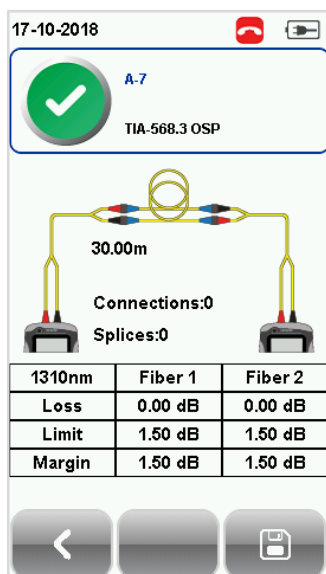

Single Mode 1310 nm

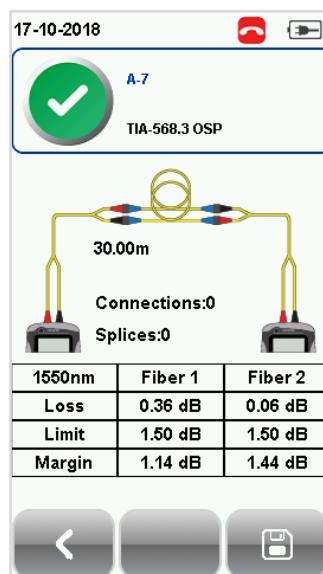

Single Mode 1550 nm

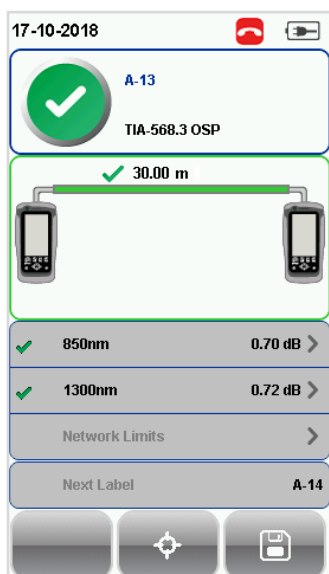

EF Multimode

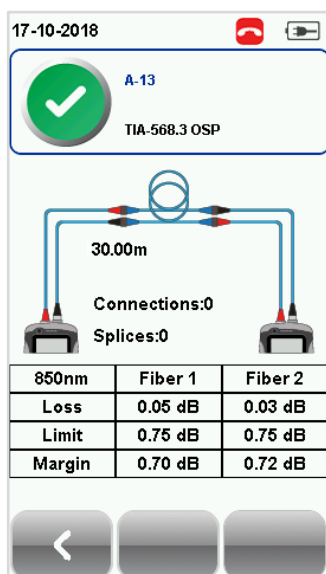

EF Multimode 850 nm

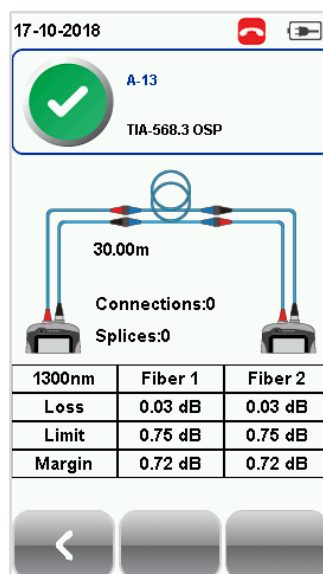

EF Multimode 1300 nm

6.2 Managing test result(s)

Test results can be manually saved by pressing the **[Save]** button after an AUTOTEST is completed. When prompted, enter label name and click **[OK]** to save.



The **[Save]** icon will disappear once saving is completed.

Pass test results will be automatically saved with reference to the selected Label Source (**[SETUP]** button → **Project Settings** → **Label Source**) when AUTOTEST is completed.

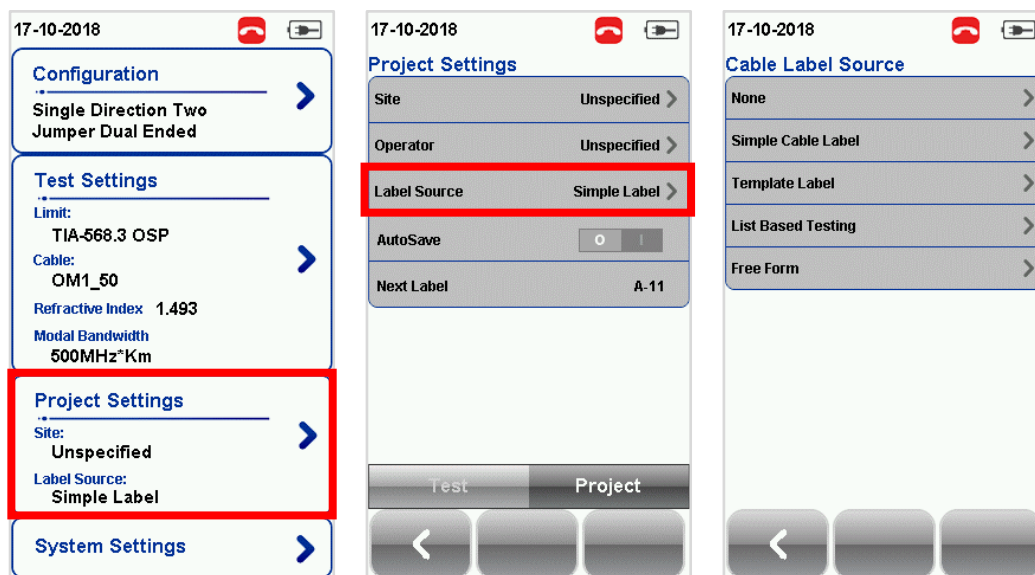

[SETUP] button

Project Settings

To view saved results,

1. Press the **[DATA]** button.
2. Select **[Fiber]** and press the **[View]** button.
3. Select the test results click **[View]** to view results.
4. Select the next page for more results.

To delete a saved result,

1. Press the **[DATA]** button.
2. Select **[Fiber]** and press the **[View]** button.
3. Press the **[Manage]** button.
4. Select result(s) and press the **[Delete]** to delete result(s).

To rename a saved result,

1. Press the **[DATA]** button.
2. Select **[Fiber]** and press the **[View]** button.
3. Press the **[Manage]** button.
4. Select result and press the **[Rename]** to rename result.

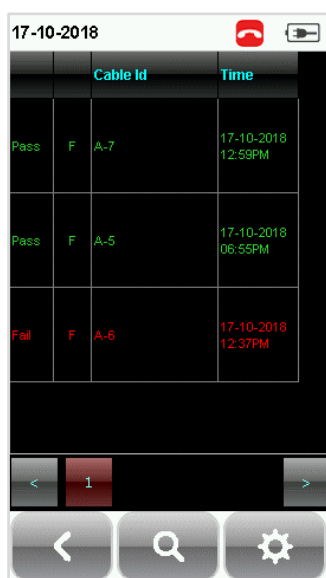
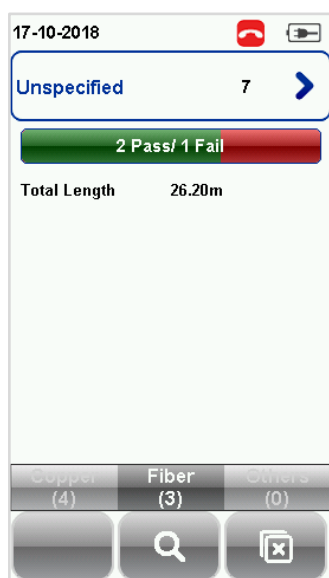

View results

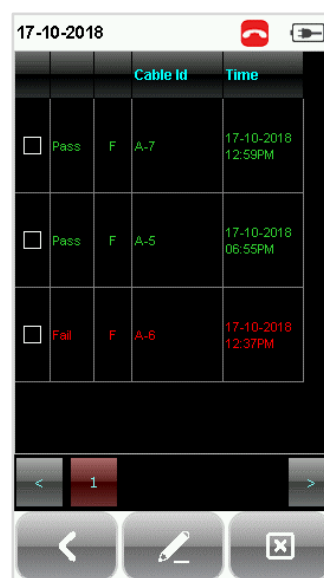

Manage results

6.3 Exporting test results into eExport PC Software

eExport is a data management software designed to work seamlessly with WireXpert.



User Manuals

Refer "User Manual – Copper Certification Testing" for more information on exporting test results into eExport PC Software.



User Manuals

Refer "User Manual – eExport" for more information on how to use the software.

7 Declarations

EU Declaration of Conformity



We

Softing Singapore Pte. Ltd.
3 Science Park Drive
#03-09, The Franklin
Singapore Science Park 1
Singapore
118223

declare under our sole responsibility that the products

Model / Description

WX4500-FA	/	WireXpert cable certifier 2500 MHz
WX500-CU	/	WireXpert cable certifier 500 MHz
WX_AD_VCL_MM1/MM2	/	Multi mode fibre adapter
WX_AD_EF_MM1/MM2	/	Multi mode fibre adapter (encircled flux compliant)
WX_AD_SM1/SM2	/	Single mode fibre adapter
WX_AD_MM_MPO_KIT/ SOURCE/PWRMETER	/	Multi mode MPO adapters

comply with the requirements of the following directives:

EMC directive 2004/108/EC (valid until April 19, 2016)
EMC directive 2014/30/EU (valid from April 20, 2016)

RoHS directive 2011/65/EU

Low Voltage Directive 2006/95/EC (valid until April 19, 2016)
Low Voltage Directive 2014/35/EU (valid from April 20, 2016)

Applied harmonised standards:

EN 55024 (2003-10) : Information technology equipment – Immunity characteristics – Limits and methods of measurement

EN 55022 (2008-05) : Information technology equipment – Radio disturbance characteristics – Limits and methods of measurement

IEC 60950-1:2005 (Second Edition) + Am 1:2009 + Am 2:2013 : Information technology equipment – Safety – Part 1 : General requirements

Simon Harrison
 General Manager

Date

Template version 2.1

Document No: 3000-0006

This device complies with the requirements of the EC directive 2004/108/EG "Electromagnetic Compatibility" (EMC directive). It meets the following requirements:

**Note**

A Declaration of Conformity in compliance with the above standards has been made and can be requested from Softing Singapore Pte Ltd.

**China ROHS**

The WireXpert device and its test components are China ROHS compliant.

**WEEE**

Electrical and electronic equipment must be disposed of separately from normal waste at the end of its operational lifetime.



Please dispose of this product according to the respective national regulations or contractual agreements. If there are any further questions concerning the disposal of this product, contact Softing IT Networks.

**CAUTION**

This is a Class A product. In a domestic environment this product may cause radio interference. In that case the user may be required to take adequate measures!

**ROHS**

The WireXpert device and its test components are ROHS compliant.

**Intertek****ETL Intertek Verified**

WireXpert device is ETL verified to ANSI/TIA IIIe, IEC 61935-1 levels IIIe& IV and currently proposed Level V draft, with the applicable measurement accuracy.

**Class 1 Laser Product**















The light source transmitted from the following fiber test modules – Single Mode (SM), Multi-Mode (MM) and Encircled Flux compliant Multi-Mode (MMEF) are classified as Class 1 lasers and are very low risk and "safe under reasonably foreseeable use", including the use of optical instruments for intrabeam viewing.









Class 1m Laser Product

The light source transmitted from the following fiber test modules – MPO REMOTE are classified as Class 1m lasers and have wavelengths between 302.5 nm and 4000 nm and are safe except when used with optical aids.

8 Appendix

 <p>[Add]– Adds a site, operator or customised cable, connector to the database.</p>	 <p>[Retest] – Performs an AUTOTEST on selected result on List-Based Testing.</p>	 <p>[Back] – Returns to previous screen. Unsaved options will be discarded.</p>
 <p>[Cancel] – Discards option.</p>	 <p>[Delete] – Deletes a site, operator or customised cable, connector from the database.</p>	 <p>[View]– View selected result.</p>
 <p>[Manage] – Enables [Rename] and [Select all] options.</p>	 <p>Format, Reset – Performs non-reversible setting/data restoration to factory defaults.</p>	 <p>Forward – Proceed to the next screen.</p>
 <p>[Device info] – Displays device firmware build information.</p>	 <p>[OK] – Confirms and saves current option.</p>	 <p>[Rename] – Renames saved test result in the DATA menu.</p>
 <p>[Restart] – Restarts current procedure.</p>	 <p>[Save] – Saves current test result. Icon will disappear after a successful save.</p>	 <p>[USB] – Reads USB flash drive to perform upgrade firmware, test result export or custom limit and label list import</p>

 <p>[Select all] – Selects all data on screen.</p>	 <p>[Next pair] – View next pair of plots of the current result.</p>	 <p>Fibermap – Displays mapping of fiber being tested.</p>
 <p>[MPO chart/grid] – Toggles between displaying of power loss in bar chart or grid format for fiber testing.</p>	 <p>[Scope live/test] – Toggles between 'Live' and 'Test' mode when inspecting a SM/MM fiber with the inspection scope.</p>	 <p>[Set Reference] – Performs result referencing between the LOCAL and REMOTE units.</p>
 <p>[Transmit ON/OFF] – Toggles between enabling and disabling of light source on the REMOTE unit.</p>		

9 Glossary

Adapter: The modular test probe used with WireXpert when used in this Manual's context, unless otherwise stated.

APC: Acronym for "Angled Physical Contact", describes the polishing of a fiber ferrule with an 8° angle to the end-face, resulting in reflected to reflect straight back towards the source, into the cladding. APC ferrules offer return losses of < -65 dB.



Bi-directional: Test procedure in WireXpert, refers to the testing of a fiber (1) from LOCAL's TX to REMOTE's RX, and a second fiber (2) from REMOTE's TX to LOCAL's RX. The procedure is repeated in a reverse direction from REMOTE's TX to LOCAL's RX on fiber 1, and LOCAL's TX to REMOTE's RX on fiber 2 by swapping the connection when prompted by WireXpert.

Boot: Part of the fiber optic connector, is the rubber strain relief piece used for reducing the strain and tension at curve transition location of a fiber optic.

Cladding: Part of the fiber optic, is one or more layers of materials to provide lower refractive at the core interface of higher refractive index.

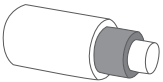

Coating: Part of the fiber optic, is the outer most layer of the fiber optic to absorb shock and provide protection to the fiber.



Core: Refers to a part of the fiber optic, is the light transmission area of the fiber. The large the core, the more light will be transmitted into the fiber.

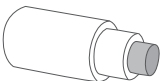

Connector: Generally referring to plugs with a protruding ferrule that holds and aligns the fibers for connecting to a device or another fiber optic.

Cord Kit: Optional fiber test kits with connector of another type for supplementary use with WireXpert adapter. Comes with test cords and accessories only. Does not include test adapters in this kit.

Coupler: Also known as mating adapters, is an optical device to connect one or more fiber ends in order to allow the transmission of light waves.

dB: Acronym for decibel, refers to the ratio unit used to measure the power level of an electrical signal by comparing it with a given level on a logarithmic scale.

dBm: Acronym for decibel-milliwatts, refers to the power ratio expressed in dB with reference to one milliwatt (mW), is used to measure the absolute power of fiber optical networks.

Device: Refers to WireXpert unit in this Manual's context, unless otherwise stated.

Dual-Ended: Performing end-to-end certification test with both LOCAL and REMOTE WireXpert.

Duplex: Generally referring to a fiber optic cable in the manual, consisting of two strands of fiber to perform separate transmit and receive of light waves.

Dust Cap: The plastic protective caps for optic connectors. Capped on the ferrule to prevent physical damages and contaminations.

EF: Acronym for Encircled Flux, refers to metric defined as the integration of intensity of light coupled into the fiber as a function of the radial distance from the center of the core. IEC 61280-4-1 standard defines the upper and lower bounds for the EF to produce reproducible launch conditions.

eXport: Project management PC software to seamlessly work with WireXpert. Required to upgrade device firmware. Not to be confused with actions "file export".

Ferrule: Part of the fiber connector, is a thin, hollow structure that firmly holds the fiber. Commonly made of ceramic, metal or high-quality plastic, and typically hold one strand of fiber.

FC: Acronym for Ferrule Core, is a type of fiber connector, using a screw-on mechanism and position key for exact positioning and securing to the socket.



Fiber Channel: A high-speed network technology primarily used to provide in-order, lossless and scalable delivery of data among data centers, servers, switches and storage up to 128 gigabit per second.

ISO: Acronym for International Organization of Standardization. Generally referring to ISO/IEC 11801 Standards for generic cabling for general purpose telecommunication cabling systems or structured cabling.

Jumper: Also known as Patch Cord, is a fiber optic patch cord that is used to connect one or more devices or equipment in a fiber optic network.

LBT: Acronym for List-Based Testing, is a unique feature of WireXpert that allows creation of label list and perform AUTOTEST in a hierarchical format.

LC: Acronym for Lucent Connector, is a type of fiber connector, with a small form factor using a 1.25mm ferrule.



Light Source: Generally referring to fiber optic light source, is used for measuring fiber optic loss for both single and multi-mode fiber cables during optical network installation, test and maintenance. Usually used with fiber optic power meters.

Link Validation: Test limit settings in WireXpert, when enabled, it is used to verify if link under test meets the user's input limit value.

LOCAL: Refers to the WireXpert unit labelled "LOCAL".

Loopback: Test method in WireXpert, refers to the simplex testing of a link using only the LOCAL unit. Test starts from LOCAL unit's TX and ends at LOCAL unit's RX, regardless number of jumpers.

Loss: Generally referring to optical loss, is the amount of light lost between the input and output of a fiber optic link. This is usually expressed in dB/km.

MMEF: Acronym for Encircled Flux compliant Multi-Mode, See EF.

MM: Acronym for Multi-Mode.

MMF: Acronym for Multi-Mode Fiber.

Modal Bandwidth: Also known as Effective Modal Bandwidth (EMB), refers to the maximum signaling rate for a given distance, or the maximum distance for a given signaling rate. This is expressed as MHz*Km.

MPO: Acronym for Multi-fiber Push-On, refers to a type of connector, for ribbon cables with four to twenty-four fibers.

OM: Acronym for Optical Multi-mode, refers to a type of fiber optic.

OS: Acronym for Optical Single-mode, refers to a type of fiber optic.

Patch Cord: Also known as Patch Cable. See Jumper.

Patch Panel: Also known as Patch Bay, is a device or unit featuring a number of jacks, for connecting and managing incoming and outgoing LAN cables.

PC: Acronym for Physical Contact connector, describes the polishing of a fiber ferrule with a slight spherical design to reduce the overall side of the end-face. PC ferrules offer return losses of < -35 dB



Power Meter: Generally referring to fiber optic power meter, is a device used to measure and testing the average power in an optical system. Usually used with fiber optic light source. The measured value is expressed in dBm.

Probe: Generally referring to a device used to connect a test equipment to a device under test, e.g., the Channel adapter and Video Inspection Scope are probes to the WireXpert.

Reference Cord: Generally referring to the patch cord used for setting reference prior to performing an AUTOTEST.

Refractive Index: Refers to the measurement of a ray of light is bent when passing from one medium into another.

REMOTE: Refers to the WireXpert unit labelled "REMOTE".

RX: Abbreviation for Receive,

Set Reference: The compensation for the effects of ambient conditions, e.g., ambient temperature, in the LOCAL and REMOTE units, to ensure maximum measurement accuracy of WireXpert.

SC: Acronym for Standard Connector, is a type of fiber connector, using a push on/pull off mechanism for securing to the socket.



ST: A type of fiber connector, using a push-in and twist mechanism for securing to the socket.



Simplex: Generally referring to a fiber optic cable in the manual, consisting of a single strand of fiber to perform either the transmit or receive of light waves, unless when performing a bi-directional test.

Single Direction: Test procedure in WireXpert, refers to the testing of a fiber from LOCAL's TX to REMOTE's RX, and a second fiber from REMOTE's TX to LOCAL's RX.

Single Ended: See Loopback.

SM: Acronym for Single Mode.

SMF: Acronym for Single Mode Fiber.

TIA: Acronym for Telecommunications Industry Association. Generally referring to TIA-568 Standards for telecommunication products and services.

TX: Abbreviation for Transmit.

UPC: Acronym for Ultra Physical Contact connector, describes the polishing of a fiber ferrule with a finer surface finishing on a convex end-face attributes similar to the PC, UPC ferrules offer return losses of < -55dB.



VFL: Acronym for Visual Fault Locator, is a method of visual inspection of a fiber optic by injecting visible light energy at one end of the fiber optic. Light will not be visible at the other end when the fiber optic is broken or faulty. WireXpert's MMEF adapter has the additional function of performing a VFL.

10 Related documents

Application Note – E2E Link Test

Application Note – MPTL

Quick Start Guide – Copper Certification Testing

Quick Start Guide – Fiber Certification Testing

Quick Start Guide – Encircled Flux Compliant Multimode Fiber Certification Testing

Quick Start Guide – MPO Certification Testing

Quick Start Guide – Digital Fiber Inspection Kit

User Manual – Fiber Certification Testing

User Manual – MPO Certification

User Manual – eXport

User Guide – List Based Testing

User Guide – Installing eXport PC Software

User Guide – License Upgrade

User Guide – eXport Cloud

User Guide – Custom Limits

11 Technical Support

Softing's global presence ensures our customers receives sales and technical support anywhere around the world. For more information: itnetworks.softing.com

The Americas

Softing Inc.

7209 Chapman Highway
Knoxville, TN 37920
Phone: +1 865 251 5252
E-mail: sales@softing.us

Asia / Pacific

Softing Singapore Pte. Ltd.

73 Science Park Drive
#02-12/13, Cintech I
Singapore Science Park 1
Singapore 118254
Phone: +65-6569-6019
E-mail: asia-sales.itnetwork@softing.com

Softing Shanghai

Room 416, 4/F, Mytech Intelligence Park,
No.1999 East Jinxiu Road, Pudong District,
201206, Shanghai, China
Phone: +86 (21) 61063031
E-mail: china-sales.itnetwork@softing.com

Europe/Middle East/Africa

Softing IT Networks GmbH

Richard-Reitzner-Alle 6
D-85540 Haar, Munich
Phone: +49 89 45 656 660
E-mail: info.itnetworks@softing.com

Softing SRL

87 Rue du Général Leclerc
Creteil, Île-de-France
94000 (Paris)
Phone: +33 1451 72805
E-mail: info.france@softing.com

Softing Italia Srl.

Via M. Kolbe, 6
20090 CesanoBoscone (MI)
Phone: +39 02 4505171
E-mail: info@softingitalia.it

Austria

Buxbaum Automation GmbH
Eisenstadt
Phone: +43 2682 7045 60
E-Mail: office@myautomation.at